

Flow Measurement

SITRANS F S Clamp-on

Clamp-on ultrasonic flowmeters SITRANS FS230

Overview



SITRANS F S clamp-on ultrasonic flowmeters provide highly accurate measurement while minimizing installation time and maintenance expense.

Benefits

- Easy installation; no need to cut pipe or stop flow
- Minimal maintenance; external sensors do not require periodic cleaning
- No moving parts to foul or wear
- No pressure drop or energy loss
- Wide turn-down ratio
- Choice of single and dual path versions to suit your operating conditions and requirements.

System performance

Approvals	<ul style="list-style-type: none"> • ATEX Zone 2 • IECEx Zone 2 • FMc Class I Div. 2
Accuracy	± 0.5 ... 1 % for velocities above 0.3 m/s and >10 diameters straight run
Repeatability	± 0.25 % (based on ISO 11631)
Pipe size range	12.7 ... 10 m (0.5 ... 394")
Wall Thickness Range	0.64 ... 76.2 mm (0.025 ... 3.0")
Pipe material	Any sonically conductive material (steel, plastic, aluminum, glass, cement, ductile iron, copper)

Applications

SITRANS FS230 standard functions are suitable for a wide variety of liquid applications, including the following:

- Water industry
 - Raw water
 - Potable water
 - Chemicals
- Wastewater industry
 - Raw sewage
 - Effluent
 - Sludges
 - Mixed liquor
 - Chemicals
- HVAC industry
 - Condensers
 - Hot and cold water systems
- Power industry
 - Nuclear
 - Fossil
 - Hydroelectric
- Processing industry
 - Process control
 - Batching
 - Rate indication
 - Volumetric and mass measurement

SITRANS FS230 hydrocarbon functions are ideal for applications carrying crude oil, refined petroleum or liquefied gas.

Standard volume (high end system)

- Standard (net) volume flow measurement
- Suitable for use in leak detection systems
- Mass flow output measurement
- Chemical and petrochemical processing
- Precise identification of interfaces on multi-liquid pipelines
- Product identification
- Standard density indication
- Applications with multiple liquids having a wide viscosity range
- Automatic gross volume compensation due to viscosity

SITRANS FS230 is ideal for most natural and process gas industry applications, including:

- Checkmetering
- Allocation
- Flow survey verification
- Lost and unaccounted for (LAUF) gas analysis
- Production
- Storage

System information SITRANS F S Clamp-on ultrasonic flowmeters

System information and selection guide

SITRANS F S clamp-on flowmeters	FS230 (Standard)	FS230 (Hydrocarbon)	FS230 (Gas)
Industry/Applications			
Water and aqueous solutions	X		
Utility district heating, cooling	X		
Chemical	X		
Hydrocarbons/petrochemical, multiple products or varying viscosity, liquefied gases, net and gross volume		X	
Hydrocarbons (single product with limited viscosity range) gross volume	X	X	
Very low flow (< 0.1 m/s) in small pipes	X		
High temperature applications < 232 °C (450 °F)	X	X	
Refrigeration liquids	X		
Food products	X		
Natural gas			X
Other gases i.e. propane, oxygen, argon etc.			X
Design			
Field clamp-on (non-intrusive)	X	X	X
Standard volume or mass flow; per API MPMS chapter 11.1		X	X
Interface detection		X	X
Standard density output		X	X
Temperature measurement	X	X	X
Analog input	X	X	X
Large graphical display	X	X	X
Configuration and diagnostic software PDM compatible	X	X	X
Number of acoustic paths and channels			
1-path	X	X	X
2-path	X	X	X
Size			
12.7 ... 10000 mm (0.5" ... 394")	X		
38 ... 10000 mm (1.5" ... 394")		X	X
Approvals			
FM/FMc ¹⁾	X	X	X
ATEX	X	X	X
UL/ULc	X	X	X
IECEX	X	X	X

¹⁾ NEMA 4X associated equipment in DIV 2 connected to DIV 1 sensors.

Flow Measurement

SITRANS F S Clamp-on

Ultrasonic flow sensor SITRANS FSS200

Function

Operating Principle

The SITRANS F S system is a transit-time ultrasonic meter that provides exceptional performance using a non-intrusive clamp-on approach. Ultrasonic sensors transmit and receive acoustic signals directly through the existing pipe wall, where the fluid refraction angle is governed by Snell's law of refraction.

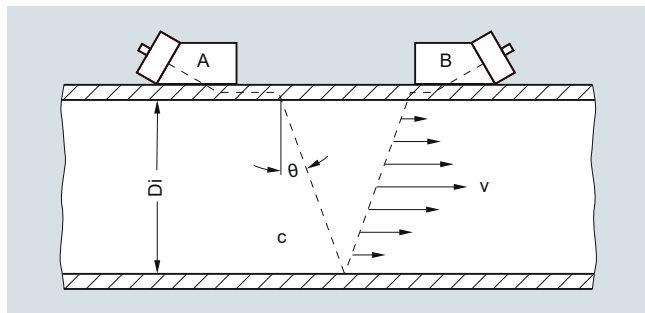

Clamp-on sensor mounted in a reflect configuration

The beam refraction angle is calculated as follows:

$$\sin \theta = c / V_{\phi}$$

c = Velocity of sound in fluid

V_{ϕ} = Phase velocity (a constant in the pipe wall)

The flowmeter automatically compensates for any change in fluid sound velocity (or beam angle) in response to variations in the average transit time between sensors A and B. By subtracting the computed fixed times (within the sensors and pipe wall) from the measured average transit time, the meter can then infer the required transit time in the fluid (T_{Fluid}).

The sound waves traveling in the same direction as the flow ($T_{A,B}$) arrive earlier than sound waves traveling against the direction of flow ($T_{B,A}$). This time difference (Δt) is used to compute the line integrated flow velocity (v) as shown in the equation below:

$$v = V_{\phi} / 2 \cdot \Delta t / T_{\text{Fluid}}$$

Once the raw flow velocity is determined, the fluid Reynolds Number (Re) must be determined to properly correct for fully developed flow profile. This requires the entry of the fluid's kinematic viscosity (visc) as shown in the equations below, where Q represents the final flow profile compensated volumetric flow rate.

$$Re = Di \cdot v / \text{visc} \cdot Q = K(Re) \cdot (\pi / 4 \cdot Di^2) \cdot v$$

v = Flow velocity

$\text{visc} = \mu / \rho$ = (dynamic viscosity / density)

$K(Re)$ = Reynolds flow profile compensation

In wetted type ultrasonic flowmeters the meter constants are configured prior to leaving the factory. As this is not possible with clamp-on meters, the settings must be made by the customer at the time of installation. These settings include pipe diameter, wall thickness, liquid viscosity, etc.

SITRANS clamp-on flowmeters that include temperature sensing can be configured to dynamically infer changes in fluid viscosity for the purpose of computing the most accurate flow profile compensation (K_{Re}).

Ultrasonic sensor types

Two basic types of clamp-on sensors can be selected for use with the SITRANS F S flowmeter. The lower cost "universal" sensor is the most common type in the industry and is suitable for most single liquid applications where the sound velocity does not vary much. This sensor type can be used on any sonically conductive pipe material (including steel) making it well suited for portable survey applications. Universal sensors are selected

based on the pipe diameter range alone, so wall thickness is less important to the selection process.

The second sensor type is the "WideBeam" sensor (called high precision), which utilizes the pipe wall as a kind of waveguide to optimize the signal to noise ratio and provide a wider area of vibration. This makes this kind of sensor less sensitive to any change in the fluid medium.

The WideBeam sensor is designed for steel pipes, but can also be used with aluminum and titanium. It is the preferred sensor for HPI applications. Note that unlike the universal type, this sensor selection is dependent only on the pipe's wall thickness.

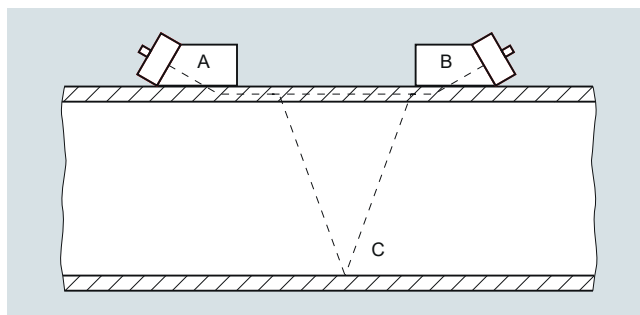

Multi-path flowmeters

For improved flow profile averaging, redundancy or better cost per measurement, clamp-on meters can be supplied with 1 or 2 path measurement systems.

In the standard FS230 systems, these can be installed on a single pipe as shown below (two paths on same pipe).

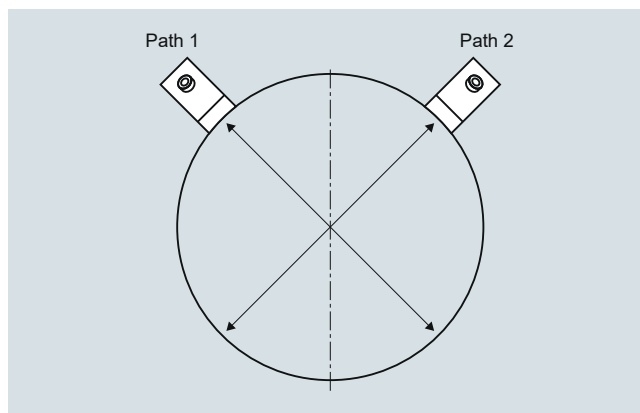

Dual path installation example

SITRANS meter family description

SITRANS FS230 clamp-on flowmeters

The FS230 system is a basic function, permanent (or dedicated) Clamp-on meter that is available with a full range of safety approvals and I/Os. This meter can be used in a wide range of applications.

FST030 transmitter standard flow functions

When configured with standard flow functions, the FST030 transmitter is typically programmed with a fixed viscosity and specific gravity entry, which can limit the mass flow and volumetric flow accuracy when highly variable (multi-product) liquid properties flow through the same pipeline.

It will have the ability to accommodate clamp-on RTDs, or analog input from a temperature transmitter.

FST030 hydrocarbon flow functions

When configured with hydrocarbon functions, the FST030 can be used for applications that will flow a wide range of viscosity with a standard volume (mass) and interface detection functions available. All functions rely on a variable referred to as "Liquident (TM)", which is used to infer the liquid's viscosity and density. This variable represents the measured liquid sonic velocity compensated by the operating temperature and pressure, so for a given liquid product the measured Liquident (TM) output will remain constant over a wide range of pressure or temperature.

Standard volume description:

This Liquident (TM) variable can also be used to identify the liquid flowing through the pipe as well as its physical properties (density, viscosity and compressibility) at base conditions. With this information the meter can be configured to output a temperature and pressure compensated (standard) volume flow rate using the API MPMS chapter 11.2.1 methods as shown below.

Correction for temperature:

Compute thermal expansion coefficient (α_b):

$$\alpha_b = KO / \rho_b^2 + K1 / \rho_b$$

where: KO and K1 are constants dependent on type of liquid and ρ_b is the liquid density at base conditions

Compute temperature correction factor (K_T):

$$K_T = \rho_b * \text{EXP}(-\alpha_b \Delta T (1 + 0.8 \alpha_b \Delta T))$$

where: $\Delta T = (T - \text{base temperature})$

Correction for pressure:

Compute compressibility factor (F):

$$F = \text{EXP}(A + B T + (C + D T) / \rho_b^2)$$

where: A, B, C and D are constants, and "T" is liquid temperature

Compute pressure correction factor (K_p):

$$K_p = 1 / (1 - F (P_{\text{act}} - P_{\text{base}}) * 10^{-4})$$

Final volume correction: $Q_{\text{std}} = Q_{\text{act}} * K_t * K_p$

Available outputs from this meter include: API, standard density, mass flowrate, standard volume flowrate and liquid identification.

General installation guidelines for transit time clamp-on sensor

- Minimum measuring range: 0 to ± 0.3 m/s velocity (see meter accuracy graph below for more detail)
- Maximum measuring range: 0 to ± 12 m/s (± 30 m/s for high precision sensors). Final flow range determination requires application review

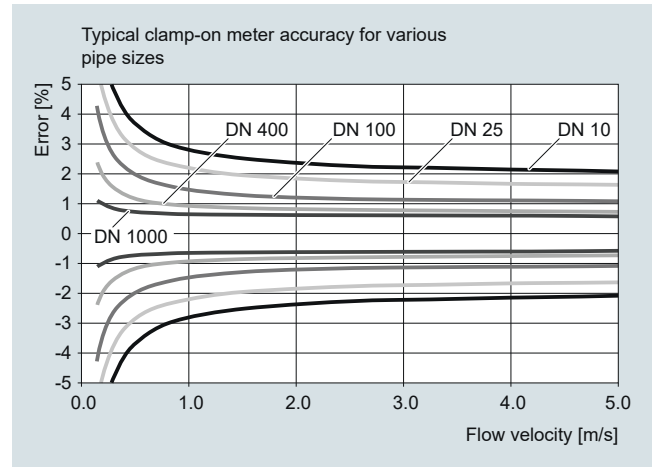

- Pipe must be completely full within the sensor installation volume for accurate flow measurement
- Typical MINIMUM straight pipe requirements are: 10 Diameters upstream/5 Diameters downstream. Additional straight run is required for double out-of-plane elbows and partially open valves.
- Sensors should be installed at least 20° off vertical for horizontal pipes. This reduces the chance of beam interference from gas buildup at the top of the pipe
- Operation inside the Reynolds transition region, between $1000 < Re < 5000$ should be avoided for best accuracy
- Submersible and direct burial installations can be accommodated. Consult sales representative for details
- Ultrasonic coupling compound is provided with all sensor orders. Insure that a permanent coupling compound is used for long term installations
- Refer to the "Sensor type selection guide" to insure proper application of the equipment

Flow Measurement

SITRANS F S Clamp-on

Ultrasonic flow sensor SITRANS FSS200

Sensor type selection guide



Standard sensor supported in MLFB

Considerations for sensor selection	High precision	Universal	Notes
Media			
General survey (clean liquids) on non-steel pipes		X	
General survey (clean liquids) on a limited range of steel pipes	X		
Moderately aerated liquid or slurry, up to 121 °C (250 °F)	X		
Permanent installation on steel pipe (clean liquids and gases)	X		
Installation in offshore or corrosive environment	X ¹⁾	X ²⁾	Sensor size C/D/E come standard as corrosion resistant. Size A and B optional stainless steel
Liquid temperature greater than 120 °C (248 °F)	O	X	FSS200 high temperature metal block sensors (up to 232 °C (450 °F))
Operation on single pipeline flowing multiple products	X	O	
Pipe material			
Steel	X		
Steel pipe with diameter/wall thickness ratio <10	O	X	
Non-steel pipe material (copper, ductile iron, cast iron, etc.)	O	X	High precision sensors can also be used on plastic and aluminum pipes in special cases
Wall thickness > 31.75 mm (1.25")	O	X	

O = not suitable X = preferred choice

¹⁾ For steel and stainless steel pipes only

²⁾ Not preferred for steel pipes

Definitions

Sensor chart	Description
FSS200	Formerly 1011 clamp-on sensors of the 1010 systems
Standard	Standard system sensor, selectable as part of a configured product
Special	Sensors available for non-standard applications and pipes. Contact tech support for application use
Corrosion resistant	Stainless steel metal parts on all Size C, D and E and all high temperature sensors
Aluminum	Aluminum metal parts on all HP and Universal size A and B (Corrosion resistant on request for size B)
Spare	Not available as part of a configured product, must be ordered separately
CE	Transmitter and sensors certified for sale in the EU
Trackless mount	Sensors fixed only by straps, no other mounting (spacer bar as an option) - not recommended
Tracks	Permanent installation for universal size A/B, high precision size A/B and all sizes of high temperature. Tracks always come as dual-part for either direct or reflect mounting, and always with straps.
Frames	Three sizes, for permanent installation for universal size C/ D/ E, and for high precision size C/D. For universal and high precision size B available for pipes > 125 OD (Spare)
T1	Usable from -40 ... +120 °C (-40 ... +248 °F), but best for Ø temperature below 80 °C (< 176 °F), standard
T2	Usable from -40 ... +120 °C (-40 ... +248 °F), but best for Ø temperature above 80 °C (> 176 °F)
Submersible	Sensors can be used submerged; adding Denso for supplemental protection is recommended

Sensor availability guide

Sensor models	Availability											
	Standard	Spare only	ATEX/FM/IECEX	Corrosion resistant	Trackless	Tracks	Frames	High precision mount	T1 best use < 80 °C (176 °F)	T2 best use > 80 °C (176 °F)	Submersible	Catalog
FSS200 Universal Sensor -40 ... 120 °C (-40 ... +248 °F) Polyetherimide - stainless steel housing CE IP68												
A1 Universal for pipe OD – 5.8 ... 50.8 mm (0.23" ... 2")		X	X	X	X ¹⁾	X					X	
A2 Universal for pipe OD – 12.7 ... 50.8 mm (0.5" ... 2")	X		X	X	X ¹⁾	X					X	X
B1 Universal for pipe OD – 12.7 ... 76 mm (0.5" ... 3")		X	X	X	X ¹⁾	X	X				X	
B2 Universal for pipe OD – 12.7 ... 76 mm (0.5" ... 3")		X	X	X	X ¹⁾	X	X				X	
B3 Universal for pipe OD – 19 ... 127 mm (0.75" ... 5")	X		X	X	X ¹⁾	X	X				X	X
C1 Universal for pipe OD – 51 ... 254 mm (2" ... 10")		X	X	X	X		X				X	
C2 Universal for pipe OD – 51 ... 254 mm (2" ... 10")		X	X	X	X		X				X	
C3 Universal for pipe OD – 51 ... 305 mm (2" ... 12")	X		X	X	X		X				X	X
D1 Universal for pipe OD – 102 ... 508 mm (4" ... 20")		X	X	X	X		X				X	
D2 Universal for pipe OD – 152 ... 610 mm (6" ... 24")		X	X	X	X		X				X	
D3 Universal for pipe OD – 203 ... 610 mm (8" ... 24")	X		X	X	X		X				X	X
*E1 Universal for pipe OD – 254 ... 3048 mm (10" ... 120")		X	X	X	X		X				X	
*E2 Universal for pipe OD – 254 ... 6096 mm (10" ... 240")	X		X	X	X		X				X	X
*E3 Universal for pipe OD – 304 ... 10007 mm (12" ... 394")		X	X	X	X		X	X			X	
FSS200 High Precision Sensor -40 ... +120 °C (-40 ... +248 °F) Polyetherimide - stainless steel housing T1/T2 CE IP68												
A1H (High Precision) for pipe WT - 0.64 ... 1.0 mm (0.025" ... 0.04")		X	X	X	X ¹⁾	X			X		X	X
A2H (High Precision) for pipe WT - 1.0 ... 1.5 mm (0.04" ... 0.06")	X		X	X	X ¹⁾	X			X		X	X
A3H (High Precision) for pipe WT - 1.5 ... 2.0 mm (0.06" ... 0.08")	X		X	X	X ¹⁾	X			X		X	X
B1H (High Precision) for pipe WT - 2.0 ... 3.0 mm (0.08" ... 0.12")	X		X	X	X ¹⁾	X	X		X	X	X	X
B2H (High Precision) for pipe WT - 3.0 ... 4.1 mm (0.12" ... 0.16")	X		X	X	X ¹⁾	X	X		X	X	X	X
B3H (High Precision) for pipe WT - 2.7 ... 3.3 mm (0.106" ... 0.128")		X	X	X	X ¹⁾	X	X		X	X	X	X
C1H (High Precision) for pipe WT - 4.1 ... 5.8 mm (0.16" ... 0.23")	X		X	X	X		X	X	X	X	X	X
C2H (High Precision) for pipe WT - 5.8 ... 8.1 mm (0.23" ... 0.32")	X		X	X	X		X	X	X	X	X	X
* D1H (High Precision) for pipe WT - 8.1 ... 11.2 mm (0.32" ... 0.44")	X		X	X	X		X	X	X	X	X	X
* D2H (High Precision) for pipe WT - 11.2 ... 15.7 mm (0.44" ... 0.62")	X		X	X	X		X	X	X	X	X	X
* D3H (High Precision) for pipe WT - 7.4 ... 9.0 mm (0.293" ... 0.354")		X	X	X	X		X	X	X	X	X	X
* D4H (High Precision) for pipe WT - 15.7 ... 31.8 mm (0.62" ... 1.25")	X		X	X	X		X	X	X	X	X	X
FSS200 High Temperature Universal Sensor -40 ... +230 °C (-40 ... +446 °F)												
High Temperature size 1 ... 230 °C (Ø 12.7 ... 100 mm)		X	X	X		X						
High Temperature size 2 ... 230 °C (Ø 30 ... 200 mm)	X		X	X		X						X
High Temperature size 3 ... 230 °C (Ø 150 ... 610 mm)	X		X	X		X						X
High Temperature size 4 ... 230 °C (Ø 400 ... 1200 mm)	X		X	X		X						X
High Temperature size 2A ... 230 °C (Ø 30 ... 200 mm)		X	X	X		X						
High Temperature size 3A ... 230 °C (Ø 150 ... 610 mm)		X	X	X		X						
High Temperature size 4A ... 230 °C (Ø 400 ... 1200 mm)		X	X	X		X						

¹⁾ Usable, but not recommended for selection.

Flow Measurement

SITRANS F S Clamp-on

Ultrasonic flow sensor SITRANS FSS200

Sensor mounting availability guide

	Sensor		
	FSS200 Dedicated Universal	FSS200 Dedicated High precision	FSS200 High temperature Universal
Mounting			
Trackless ¹⁾	X	X	
Tracks universal dedicated	X		
Tracks HP dedicated		X	
Frames universal dedicated	X		
Frames HP dedicated		X	
Tracks high temperature universal			X
High precision mounting single enclosure		X	
High precision mounting dual enclosure		X	
SpacerBar	X	X	
Straps	X	X	X
Chains EZ-Clamp 1	Size C, D	Size C	
Chains EZ-Clamp 2	Size E	Size D	
Denso	X	X	

¹⁾ Usable but not recommended

Overview

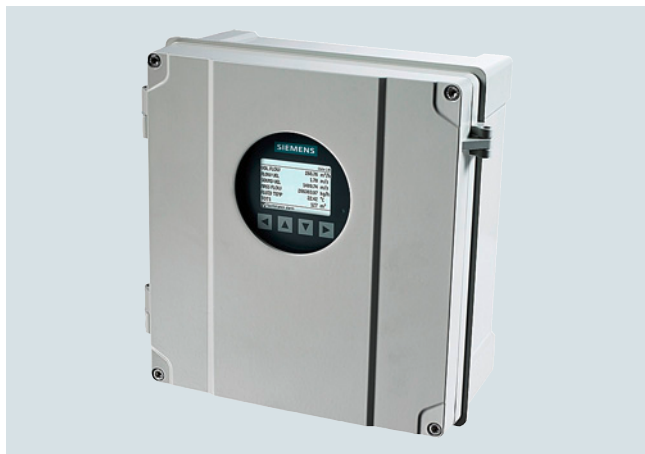

FST030 is based on the latest developments within Digital Signal Processing (DSP) technology – engineered for high measuring performance, fast response to step changes in flow, high immunity against process noise, easy to install commission and maintain.

The FST030 transmitter delivers true multi-parameter measurements i.e. volume flow, standard volume flow, density, mass flow, fluid sound velocity and temperature.

The multiple outputs and bus communication mean that all primary process information can be read either instantaneously (10 ms update) or periodically as required by plant operations.

Process values

- Volume flow
- Mass flow
- Flow velocity
- Sound velocity
- Standard volume flow (hydrocarbon variant only)
- Density
- Kinematic viscosity
- Pressure
- Medium temperature
- Specific gravity (hydrocarbon variant only)
- Totalizer 1
- Totalizer 2
- Totalizer 3
- Standard density (hydrocarbon variant only)
- Standard specific gravity (hydrocarbon variant only)
- Standardizing factor (hydrocarbon variant only)
- Liquident (hydrocarbon variant only)
- API gravity (hydrocarbon variant only)
- Standard API gravity (hydrocarbon variant only)
- Standard kinematic viscosity (hydrocarbon variant only)
- Liquid identifier (hydrocarbon variant only)

Benefits

Flow calculation and measurement

- Dedicated volume flow calculation with DSP technology
- 100 Hz update rate for all output on all primary process values
- Maximum data age from sensor to output is 20 ms
- Independent low flow cut-off settings for volume and mass flow, standard volume flow and velocity
- Zero-point adjustment on command from discrete input or host system

Operation and display

- User-configurable operation display
 - Full graphical display 240 x 160 pixels with up to 6 programmable views
 - Self-explaining alarm handling/log in clear text
 - Help text for all parameters appears automatically in the configuration menu
- SensorFlash technology stores production specific system documentation and provides removable memory of all flowmeter setups and functions
 - Calibration certificates (with ordered calibration)
 - Non-volatile memory backup of operational data
 - Transfer of user configuration to other flowmeters
 - 4GB SD card for storage and data logging
 - Audit trail of all parameter changes
 - Alarm logging

Alarms and safety

- Advanced diagnosis and service menu enhances troubleshooting and meter validation
- Configurable upper and lower alarm and warning limits for all process values
- Alarm handling can be selected between Siemens and NAMUR standard configurations

Outputs and control

- Monitoring comprising of 3 individually configurable totalizers
- Multi-parameter outputs, configurable outputs assigned individually to any of the following parameters:
 - Volume flow
 - Standard volume flow
 - Mass flow
 - Flow velocity
 - Sound velocity
 - Density
 - Process viscosity
 - Process pressure
 - Process/medium temperature

Up to six I/O channels are configured as follows.

Channel 1

Channel 1 is 4 to 20 mA analog output with HART 7.5. The current signal can be configured for massflow, volume flow and includes the availability of active or passive function selected by wiring on the non-Ex terminals. Alternative Modbus RTU RS 485 is available.

Channel 2

Channel 2 is a signal output which can be freely configured for any process variable.

- Analog current (0/4 to 20 mA)
- Frequency or pulse
- Operational and alarm status

Channels 3 and 4

Channels 3 and 4 can be ordered with signal (freely configured for any process variable) or relay outputs, or signal input.

Flow Measurement

SITRANS F S Clamp-on

Transmitter SITRANS FST030, wall mount housing

Signal output

Signal output can be user configured to:

- Analog current (0/4 to 20 mA)
- Frequency or pulse
- Redundant frequency or pulse (linked to channel 2)
- Operational and alarm status

Signal input

Signal input can be user-configured for:

- Totalizer reset functions
- Force outputs or freeze process values
- Initiate automatic zero point adjustment

Relay

Relay output(s) can be user configured to:

- Alarm status

4-20 mA signal outputs and inputs are ordered as active or passive for Ex versions, active and passive for non-Ex versions - function selected by wiring on the terminals.

During initial commissioning of the flowmeter, all outputs can be forced to a preset value for simulation, verification or calibration purposes.

Channels 5 and 6

- RTD temperature inputs for 1000, 500 or 100 Ω RTD's - 2, 3 or 4 wire RTD's supported

Approvals and certificates

The SITRANS FST030 transmitter was designed to comply with or exceed the requirements of international standards and regulations.

Design

The SITRANS FST030 is designed in an IP67/NEMA 4X aluminum enclosure with corrosion resistant coating. It can be wall or pipe mounted and the enclosure can be locked with a padlock or wired with lead security seals. Includes all flow and DSL functions integrated into one unit.

The FST030 is available as standard with one current, HART 7.5 output and can be ordered with additional input/output functions.

The transmitter has a modular design with discrete, replaceable electronic modules and connection boards to maintain separation between functions and facilitate field service. All modules are fully traceable and their provenance is included in the transmitter setup.

SensorFlash

SensorFlash is a standard, 4 GB micro SD card with the ability to be updated by PC. It is supplied with each transmitter and comes with a complete set of certification documents including report if ordered. Factory conformance certificates are optional at ordering.

The Siemens SensorFlash memory unit offers the following features and benefits:

- Copy site setups to SD card for easy transfer to other similar transmitters
- Permanent database of operational and functional information from the moment that the flowmeter is switched on
- New firmware updates can be downloaded from the Siemens internet portal for Product Support and placed onto SensorFlash (unmounted from the transmitter and inserted into a PC's SD card slot). The firmware is then inserted into the existing flowmeter for system/firmware upgrade.

Function

The following functions are available:

- Up to four configurable outputs and 2 RTD input channels selected at ordering
- Outputs can be individually configured for mass flow, volume flow etc.
- Three built-in totalizers which can count positive, negative or net flows
- Independent low flow cut-offs, adjustable
- Uni/bidirectional flow measurement
- Flow direction adjustable
- Alarm system consisting of alarm-log, alarm pending menu
- Change log, logs all changes made to menu parameters or via communications
- Internal data logger
- Display of operating time with real-time clock
- Flowrate outputs are freely configurable between maximum negative and maximum positive flows according to the sensor capacity
- Limit switches programmable for flow, density and temperature. Limit points can be graded as warning and alarm for values both above and below nominal process conditions
- Zero adjustment menu, with zero point evaluation display
- Full service menu for effective and straight forward application and meter troubleshooting
- Precise temperature measurement ensures optimal accuracy on massflow and density
- Fully compatible with Siemens PDM version 8.2 service pack 1 or higher

Technical specifications

Process media	<ul style="list-style-type: none"> • Suitable for virtually any sonically conductive fluid, including hazardous liquids • Aggregate state: Light slurry and liquid 	Galvanic isolation	All inputs and outputs are galvanically isolated, isolation voltage 500 V
Process variables	<ul style="list-style-type: none"> • Volume flow • Mass flow • Flow velocity • Sound velocity • Standard volume flow (hydrocarbon variant only) • Density • Kinematic viscosity • Pressure • Medium temperature • Specific gravity (hydrocarbon variant only) • Totalizer 1 • Totalizer 2 • Totalizer 3 • Standard density (hydrocarbon variant only) • Standard specific gravity (hydrocarbon variant only) • Standardizing factor (hydrocarbon variant only) • Liquident (hydrocarbon variant only) • API gravity (hydrocarbon variant only) • Standard API gravity (hydrocarbon variant only) • Standard kinematic viscosity (hydrocarbon variant only) • Liquid identifier (hydrocarbon variant only) 	Alarm and warning limit	Available for all process values
Current output		Totalizer	Three counters for forward, net and reverse flow
Current	0 ... 20 mA or 4 ... 20 mA (channel 1 only 4 ... 20 mA)	Display	<ul style="list-style-type: none"> • Background illumination with alpha-numerical text to indicate flow rate, totalized values, settings and faults • Adjustable damping constant of 0 ... 100 s • Reverse flow indicated by negative sign
Load	< 500 Ω per channel	SD card functions	<ul style="list-style-type: none"> • Parameter change log • Configurable data logger • FW update log • Diagnostic log • Error and alarm log • Parameter backup
Time constant	0 ... 100 s adjustable	Ambient temperature	
Digital output¹⁾		Operation	
Pulse	41.6 μs ... 5 s pulse duration	• Transmitter	-40 ... +60 °C (-40 ... +140 °F), (humidity max. 95 %)
Frequency	0 ... 10 kHz, 50 % duty cycle, 120 % overscale provision	• Display	-20 ... +60 °C (-4 ... +140 °F)
Time constant	0 ... 100 s adjustable	Storage	
Active	0 ... 22 V DC, 30 mA, short-circuit-protected	• Transmitter	-40 ... +70 °C (-40 ... +158 °F) (humidity max. 95 %)
Passive	3 ... 30 V DC, max. 110 mA	Communication	HART 7.5 Modbus RTU RS 485
Relay		Enclosure	
Type	SPDT dry contact relay	Material	Aluminum
Load	30 V AC/100 mA	Rating	IP66/67, NEMA 4X to IEC 529 and DIN 40050 (1 mH ₂ O for 30 min.)
Functions	Alarm level, alarm number, limit, flow direction	Mechanical load	18 ... 400 Hz random, 3.17 g RMS, in all directions
Digital input		Power supply	
Voltage	15 ... 30 V DC (2 ... 15 mA)	Universal	20 ... 27 V DC 100 ... 240 V AC, 47 ... 63 Hz
Current	4 ... 20 mA	Fluctuation	No limit
Functionality	Reset totalizer 1, 2 and 3, force output, freeze process values, zero point adjustment	Power consumption	20 W/22 VA
		Environment	
		Environmental conditions acc. to IEC/EN/UL 61010-1	<ul style="list-style-type: none"> • Altitude up to 2000 m • Pollution degree 2 • Overvoltage category II
		Maintenance	The flowmeter has a built-in error log/pending menu which should be inspected on a regular basis
		Cable glands	Cable glands are available in nylon, nickel plated brass or stainless steel (316L/W1.4404)

Flow Measurement

SITRANS F S Clamp-on

Transmitter SITRANS FST030, wall mount housing

Approvals

For non-hazardous area	No approval required
For hazardous area	
• ATEX	
- Sensor	Zone 0, 1, 2
- Transmitter with integrated DSL	Zone 2
• FM	
- Sensor	Class 1, Div 1, 2
- Transmitter	Class 1, Div 2
• FM Canada	
- Sensor	Class 1, Div 1, 2 (Zone 0, 1, 2)
- Transmitter with integrated DSL	Class 1, Div 2 (Zone 2)
• Combination Approval: ATEX, IECEx, FM, FM Canada	
- Sensor	Zone 0, 1, 2 (Div 1,2)
- Transmitter with integrated DSL	Zone 2 (Div 2)

Certificates

CE conformity marking	<ul style="list-style-type: none"> • Low voltage directive • WEEE • RoHS
-----------------------	---

EMC performance

Emission	CISPR 11:2009/A1:2010 and EN 55011:2009/A1:2010
Immunity	IEC/EN 61326-1:2013

Dimensional drawing

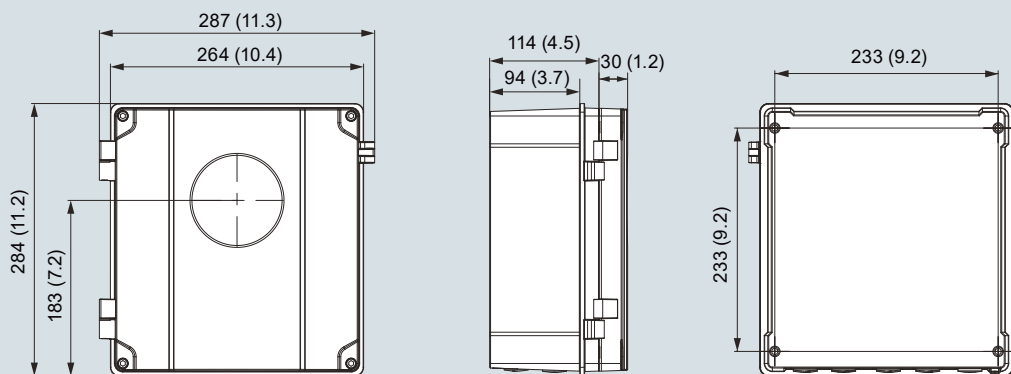

SITRANS FST030, wall mount version, dimensions in mm (inch)

Ultrasonic flowmeter SITRANS FS230 - Ordering data

Selection and Ordering data	Article No.	Ord. code
SITRANS FS230 clamp-on flowmeter	7ME372	
Click on the Article No. for the online configuration in the PIA Life Cycle Portal.		
Transmitter model		
No transmitter, external DSL only	0	
Transmitter FST030	3	
Pipe material/temperature		
Transmitter only - no sensor	0	
Steel (stainless steel, carbon steel), temperature range: best use < 80 °C (176 °F)	1	
Steel (stainless steel, carbon steel), temperature range: best use > 80 °C (176 °F)	2	
Plastic (PVC) (for gas applications), temperature: -40 ... 65.5 °C (-40 ... 150 °F)	4	
Plastic (PVC) (for liquid applications), temperature: -40 ... +121 °C (-40 ... 250 °F)	6	
Any material, temperature: -40 ... +121 °C (-40 ... 250 °F)	7	
Any material, very high temperature: -40 ... +230 °C (-40 ... 446 °F)	8	
Pipe outer diameter range		
Transmitter only - no sensor		A
13 ... 19 mm (0.5 ... 0.75")		B
19.3 ... 30.5 mm (0.76 ... 1.20")		C
30.7 ... 50.8 mm (1.21 ... 2.00")		D
51 ... 76 mm (2.01 ... 3.00")		E
78 ... 127 mm (3.1 ... 5.0")		F
129 ... 203 mm (5.1 ... 8.0")		G
206 ... 305 mm (8.1 ... 12.0")		H
307 ... 508 mm (12.1 ... 20.0")		J
510 ... 813 mm (20.1 ... 32.0")		K
815 ... 9144 mm (32.1 ... 360")		L
Pipe wall thickness range		
Transmitter only - no sensor		A
0.635 ... 1.016 mm (0.025 ... 0.04")		B
1.016 ... 1.524 mm (0.04 ... 0.06")		C
1.524 ... 2.032 mm (0.06 ... 0.08")		D
2.032 ... 3.048 mm (0.08 ... 0.12")		E
3.048 ... 4.064 mm (0.12 ... 0.16")		F
4.064 ... 5.842 mm (0.16 ... 0.23")		G
5.842 ... 8.128 mm (0.23 ... 0.32")		H
8.128 ... 11.176 mm (0.32 ... 0.44")		J
11.176 ... 15.748 mm (0.44 ... 0.62")		K
15.748 ... 31.75 mm (0.62 ... 1.25")		L
31.75 ... 50.8 mm (1.25 ... 2.00")		M
Sensor mounting		
Transmitter only - no sensor		0
Mounting straps only		1
Standard frames and tracks		2
Magnetic - no straps		4
Magnetic - with straps		6
High precision mount (single enclosure)		7
High precision mount (dual enclosure)		8
Number of paths (sensor pairs)		
Transmitter only - no sensor		0
One path		1
Two path		2
Environment		
Standard		1

Flow Measurement

SITRANS F S Clamp-on

Ultrasonic flowmeter SITRANS FS230 - Ordering data

Selection and Ordering data	Article No.	Ord. code
SITRANS FS230 clamp-on flowmeter	7ME372 - - - - -	
Transmitter/DSL material and mounting style Wallmount transmitter, internal DSL, transmitter: aluminum wallbox, NEMA 4X, DSL: none, direct connected sensor cables, (max 2-path, max. 20 meter sensor cable)		U
Ex approvals Non-Ex ATEX, wallbox enclosure FM, wallbox enclosure FMc, wallbox enclosure ATEX, IECEx, FM, FMc, wallbox		A B G L P
Local User Interface Blind version transmitter Graphical local user interface, 240 x 160 pixels		1 3

3

Ultrasonic flowmeter SITRANS FS230 - Ordering data

Selection and Ordering data	Order code	Selection and Ordering data	Order code
Further designs		Ex Passive	
Please add "-Z" to Article No. and specify Order code(s).		• Ch2: current/freq./pulse, Ch3: none, Ch4: none	F21
Cable glands - transmitter, DSL (not for sensor cables)		• Ch2: current/freq./pulse, Ch3: current/freq./pulse Ch4: None	F22
No glands, metric threads on transmitter	A01	• Ch2:current/freq./pulse, Ch3: current/freq./pulse Ch4:current/freq./pulse	F23
No glands, metric thread with NPT thread adapters, stainless steel: quantity based on selection "U" in data place 14	A60	• Ch2: current/freq./pulse, Ch3: current/freq./pulse Ch4: relay	F24
No glands, metric thread with NPT thread adapters, nickel plated brass: quantity based on selection "U" in data place 14	A61	• Ch2: current/freq./pulse, Ch3: relay, Ch4: relay	F25
Nickel plated brass glands: quantity based on selection "U" in data place 14	A62	• Ch2: current/freq./pulse, Ch3: relay, Ch4: none	F26
Plastic glands: quantity based on selection "U" in data place 14	A64	Temperature sensors and pockets	
Stainless steel glands: quantity based on selection "U" in data place 14	A66	1000 Ω platinum standard clamp-on RTD	J61
Software functions and CT approvals		1000 Ω platinum submersible clamp-on RTD	J62
Software: for standard industry applications	B11	Sensor to transmitter cables	
Software including hydrocarbon process values	B39	10 m (32.8 ft) standard/submersible coax sensor cable pair with nylon glands	K24
Software including gas process values	B50	20 m (65.6 ft) standard/submersible coax sensor cable pair with nylon glands	K25
I/O configuration Ch1		10 m (32.8 ft) standard/submersible coax sensor cable pair with nickel plated brass glands	K29
Non-Ex, 4 ... 20 mA HART, menu selected pas- sive/active	E02	20 m (65.6 ft) standard/submersible coax sensor cable pair with nickel plated brass glands	K30
Ex, 4 ... 20 mA HART, active	E06	10 m (32.8 ft) standard/submersible coax sensor cable pair with stainless steel glands	K34
Ex, 4 ... 20 mA HART, passive	E07	20 m (65.6 ft) standard/submersible coax sensor cable pair with stainless steel glands	K35
Modbus RTU 485	E14	20 m (65.6 ft) plenum rated coax sensor cable pair with nylon glands	K37
I/O configuration Ch2, Ch3 and Ch4		20 m (65.6 ft) plenum rated coax sensor cable pair with nickel plated brass glands	K39
None	F00	20 m (65.6 ft) plenum rated coax sensor cable pair with stainless steel glands	K41
Non-Ex		10 m (32.8 ft) armored sensor cable pair with nickel plated brass glands	K53
• Ch2: current/freq./pulse, Ch3: none Ch4: none. Active/passive menu selected	F01	20 m (65.6 ft) armored sensor cable pair with nickel plated brass glands	K54
• Ch2: current/freq./pulse, Ch3: current/freq./pulse Ch4: none. Active/passive menu selected	F02		
• Ch2:current/freq./pulse, Ch3: current/freq./pulse Ch4:current/freq./pulse. Active/passive menu selected	F03		
• Ch2:current/freq./pulse, Ch3: current/freq./pulse Ch4: relay. Active/passive menu selected	F04		
• Ch2: current/freq./pulse, Ch3: relay Ch4: relay. Active/passive menu selected	F05		
• Ch2: current/freq./pulse, Ch3: relay Ch4: none. Active/passive menu selected	F06		
Ex Active			
• Ch2: current/freq./pulse, Ch3: none Ch4: none	F11		
• Ch2: current/freq./pulse, Ch3: current/freq./pulse Ch4: none	F12		
• Ch2: current/freq./pulse, Ch3: current/freq./pulse Ch4: current/freq./pulse	F13		
• Ch2: current/freq./pulse, Ch3: current/freq./pulse, Ch4: relay	F14		
• Ch2: current/freq./pulse, Ch3: relay, Ch4: relay	F15		
• Ch2: current/freq./pulse, Ch3: relay, Ch4: none	F16		

Flow Measurement

SITRANS F S Clamp-on

Ultrasonic flowmeter SITRANS FS230 - Ordering data

Selection and Ordering data	Order code
RTD cable (clamp temperature sensor to transmitter)	
6 m (20 ft) standard RTD cable	R50
15 m (50 ft) standard RTD cable	R51
30 m (100 ft) standard RTD cable	R52
46 m (150 ft) standard RTD cable	R53
61 m (200 ft) standard RTD cable	R54
91 m (300 ft) standard RTD cable	R55
6 m (20 ft) submersible RTD cable	R56
15 m (50 ft) submersible RTD cable	R57
30 m (100 ft) submersible RTD cable	R58
46 m (150 ft) submersible RTD cable	R59
61 m (200 ft) submersible RTD cable	R60
91 m (300 ft) submersible RTD cable	R61
RTD cable (insert temperature sensor to transmitter)	
15 m (50 ft) RTD cable with nickel plated gland	R74
15 m (50 ft) RTD cable with stainless steel gland	R75
30 m (100 ft) RTD cable with nickel plated gland	R76
30 m (100 ft) RTD cable with stainless steel gland	R77
91 m (300 ft) RTD cable with nickel plated gland	R78
91 m (300 ft) RTD cable with stainless steel gland	R79
15 m (50 ft) insert RTD cable with nickel plated gland	R80
15 m (50 ft) insert RTD cable with stainless steel gland	R81
30 m (100 ft) insert RTD cable with nickel plated gland	R82
30 m (100 ft) insert RTD cable with stainless steel gland	R83
91 m (300 ft) insert RTD cable with nickel plated gland	R84
91 m (300 ft) insert RTD cable with stainless steel gland	R85
Mass storage	
Enable mass storage function for SD card (not available for USA)	S30
Tag plate	
Tag plate for transmitter, stainless steel	Y15
Tag name plate, stainless steel	Y17

Selection and Ordering data	Article No.
System spare parts	
Tool kits and loose parts	
"F" connector tool kit, 2 per	A5E38145699
Bag of loose spare parts; for wallmount, including cable strain relief components, mounting tool, seals and gasket, assorted screws and washers, hex cap nut, blind plugs, and O-rings	A5E38288072
Electronics assemblies and modules	
Wall box	
• Display and keypad assembly	A5E37697615
• Digital Sensor Link (DSL), internal, for wall box, standard process values	A5E38014726
• Digital Sensor Link (DSL), internal, for wall box, hydrocarbon process values	A5E42138542
• Digital Sensor Link (DSL), internal, for wall box, gas process values	A5E47202379
• SensorFlash (4 GB micro SD card) -40 °C ... +85 °C	A5E38288507
• Power supply, for wall box, (240 V AC, 47 ... 63 Hz), (24 ... 90 V DC)	A5E38263021
• Foam insert for wall box with connectors	A5E38287828
Cassettes, I/O configuration and communication	
Ex	
• Ch1: I/O and comm (active) 4 ... 20 mA output and HART 7.2	A5E38012278
• Ch1: I/O and comm (passive) 4 ... 20 mA output and HART 7.2	A5E38013025
• Ch1: communication Modbus RTU 485	A5E38013054
Non Ex	
• Ch1: I/O and comm (active/passive) 4 ... 20 mA output and HART 7.2	A5E38013040
• Ch1: communication Modbus RTU 485	A5E38013069
• Ch2: current/freq./pulse, Ch3: None Ch4: none. Menu select active/passive	A5E38006256
• Ch2: current/freq./pulse, Ch3: current/freq./pulse Ch4: none. Menu select active/passive	A5E38006558
• Ch2: current/freq./pulse, Ch3: current/freq./pulse Ch4: current/Freq./Pulse. Menu select active/passive	A5E38006598
• Ch2: current/freq./pulse, Ch3: current/freq./pulse Ch4: relay. Menu select active/passive	A5E38006896
• Ch2: current/freq./pulse, Ch3: relay Ch4: relay. Menu select active/passive	A5E38006900
• Ch2: current/freq./pulse, Ch3: relay Ch4: none. Menu select active/passive	A5E38011432
Ex Passive	
• Ch2: current/freq./pulse, Ch3: None Ch4: none	A5E38012039
• Ch2: current/freq./pulse, Ch3: current/freq./pulse Ch4: none	A5E38012056
• Ch2: current/freq./pulse, Ch3: current/freq./pulse Ch4: current/freq./pulse	A5E38012121
• Ch2: current/freq./pulse, Ch3: current/freq./pulse Ch4: relay	A5E38019235
• Ch2: current/freq./pulse, Ch3: relay Ch4: relay	A5E38019263
• Ch2: current/freq./pulse, Ch3: relay Ch4: none	A5E38019378
Ex Active	
• Ch2: current/freq./pulse, Ch3: none Ch4: none	A5E38011478
• Ch2: current/freq./pulse, Ch3: current/freq./pulse Ch4: none	A5E38011509
• Ch2: current/freq./pulse, Ch3: current/freq./pulse Ch4: current/freq./pulse	A5E38011541
• Ch2: current/freq./pulse, Ch3: current/freq./pulse Ch4: relay	A5E38011600
• Ch2: current/freq./pulse, Ch3: relay Ch4: relay	A5E38011618
• Ch2: current/freq./pulse, Ch3: relay Ch4: none	A5E38011908
Miscellaneous parts	
Wall bracket "pipe mounting"	A5E38288020
Wall bracket "panel mounting"	A5E38288032
Metal kit: PSU cover, back plane	A5E38415145
Power input cover plate	A5E38415205
Blind plug brass-nickel 10 pcs (Ex version)	A5E38145685
Blind plug stainless steel 10 pcs (Ex version)	A5E38145689
F connectors, 4 pcs	A5E38268608

Flow Measurement

SITRANS F S Clamp-on

Ultrasonic flowmeter SITRANS FS230 - Accessories/Spare parts

Article No./Sensor Crossreference

Steel (T1)			Steel (T2)			Plastic (liquid)		
Data place 8,9,10 of 7ME372-... combination	Sensor part number	Sensor Size Code	Data place 8,9,10 of 7ME372-... combination	Sensor part number	Sensor Size Code	Data place 8,9,10 of 7ME372-... combination	Sensor part number	Sensor Size Code
1BB	7ME3950-5LG01	A1HT1	2BB	7ME3950-5LB11	A1	6BB	7ME3950-5LB01	A2
1BC	7ME3950-5LH01	A2HT1	2BC	7ME3950-5LB01	A2	6BC	7ME3950-5LB01	A2
1BD	7ME3950-5LB11	A1	2BD	7ME3950-5LB11	A1	6BD	7ME3950-5LB01	A2
1BE	7ME3950-5LB01	A2	2BE	7ME3950-5LB01	A2	6BE	7ME3950-5LB01	A2
1BF	7ME3950-5LB11	A1	2BF	7ME3950-5LB11	A1	6BF	7ME3950-5LB01	A2
1CB	7ME3950-5LG01	A1HT1	2CB	7ME3950-5LB11	A1	6CB	7ME3950-5LB01	A2
1CC	7ME3950-5LH01	A2HT1	2CC	7ME3950-5LB01	A2	6CC	7ME3950-5LB01	A2
1CD	7ME3950-5LJ01	A3HT1	2CD	7ME3950-5LB11	A1	6CD	7ME3950-5LB01	A2
1CE	7ME3950-5GK01	B1HT1	2CE	7ME3950-5GK21	B1HT2	6CE	7ME3950-5LB01	A2
1CF	7ME3950-5LB11	A1	2CF	7ME3950-5LB11	A1	6CF	7ME3950-5LB01	A2
1CG	7ME3950-5LB11	A1	2CG	7ME3950-5LB11	A1	6CG	7ME3950-5LB01	A2
1DB	7ME3950-5LG01	A1HT1	2DB	7ME3950-5LC11	B1	6DC	7ME3950-5LC01	B3
1DC	7ME3950-5LH01	A2HT1	2DC	7ME3950-5LC21	B2	6DD	7ME3950-5LC01	B3
1DD	7ME3950-5LJ01	A3HT1	2DD	7ME3950-5LC11	B1	6DE	7ME3950-5LC01	B3
1DE	7ME3950-5GK01	B1HT1	2DE	7ME3950-5GK21	B1HT2	6DF	7ME3950-5LC01	B3
1DF	7ME3950-5GL01	B2HT1	2DF	7ME3950-5GL21	B2HT2	6DG	7ME3950-5LC01	B3
1DG	7ME3950-5LC01	B3	2DG	7ME3950-5LC01	B3	6DH	7ME3950-5LC01	B3
1DH	7ME3950-5LC21	B2	2DH	7ME3950-5LC21	B2	6EC	7ME3950-5LC01	B3
1EB	7ME3950-5LG01	A1HT1	2EB	7ME3950-5LC11	B1	6ED	7ME3950-5LC01	B3
1EC	7ME3950-5LH01	A2HT1	2EC	7ME3950-5LC21	B2	6EE	7ME3950-5LC01	B3
1ED	7ME3950-5LJ01	A3HT1	2ED	7ME3950-5LC11	B1	6EF	7ME3950-5LC01	B3
1EE	7ME3950-5GK01	B1HT1	2EE	7ME3950-5GK21	B1HT2	6EG	7ME3950-5LC01	B3
1EF	7ME3950-5GL01	B2HT1	2EF	7ME3950-5GL21	B2HT2	6EH	7ME3950-5LC01	B3
1EG	7ME3950-5GM00	C1HT1	2EG	7ME3950-5GM20	C1HT2	6EJ	7ME3950-5LC01	B3
1EH	7ME3950-5GN00	C2HT1	2EH	7ME3950-5GN20	C2HT2	6EK	7ME3950-5LC01	B3
1EJ	7ME3950-5LC01	B3	2EJ	7ME3950-5LC01	B3	6FE	7ME3950-5LD00	C3
1EK	7ME3950-5LC01	B3	2EK	7ME3950-5LC01	B3	6FF	7ME3950-5LD00	C3
1FC	7ME3950-5LH01	A2HT1	2FC	7ME3950-5LD10	C1	6FG	7ME3950-5LD00	C3
1FD	7ME3950-5LJ01	A3HT1	2FD	7ME3950-5LD10	C1	6FH	7ME3950-5LD00	C3
1FE	7ME3950-5GK01	B1HT1	2FE	7ME3950-5GK21	B1HT2	6FJ	7ME3950-5LD00	C3
1FF	7ME3950-5GL01	B2HT1	2FF	7ME3950-5GL21	B2HT2	6FK	7ME3950-5LD00	C3
1FG	7ME3950-5GM00	C1HT1	2FG	7ME3950-5GM20	C1HT2	6GF	7ME3950-5LD00	C3
1FH	7ME3950-5GN00	C2HT1	2FH	7ME3950-5GN20	C2HT2	6GG	7ME3950-5LD00	C3
1FJ	7ME3950-5GP00	D1HT1	2FJ	7ME3950-5GP20	D1HT2	6GH	7ME3950-5LD00	C3
1FK	7ME3950-5LD10	C1	2FK	7ME3950-5LD10	C1	6GJ	7ME3950-5LD00	C3
1GD	7ME3950-5LJ01	A3HT1	2GD	7ME3950-5LD10	C1	6GK	7ME3950-5LD00	C3
1GE	7ME3950-5GK01	B1HT1	2GE	7ME3950-5GK21	B1HT2	6GL	7ME3950-5LD00	C3
1GF	7ME3950-5GL01	B2HT1	2GF	7ME3950-5GL21	B2HT2	6HG	7ME3950-5LE00	D3
1GG	7ME3950-5GM00	C1HT1	2GG	7ME3950-5GM20	C1HT2	6HH	7ME3950-5LE00	D3
1GH	7ME3950-5GN00	C2HT1	2GH	7ME3950-5GN20	C2HT2	6HJ	7ME3950-5LE00	D3
1GJ	7ME3950-5GP00	D1HT1	2GJ	7ME3950-5GP20	D1HT2	6HK	7ME3950-5LE00	D3
1GK	7ME3950-5GQ00	D2HT1	2GK	7ME3950-5GQ20	D2HT2	6HL	7ME3950-5LE00	D3
1GL	7ME3950-5LD00	C3	2GL	7ME3950-5LD00	C3	6HM	7ME3950-5LE00	D3
1HE	7ME3950-5GK01	B1HT1	2HE	7ME3950-5GK21	B1HT2	6JJ	7ME3950-5LE00	D3
1HF	7ME3950-5GL01	B2HT1	2HF	7ME3950-5GL21	B2HT2	6JK	7ME3950-5LE00	D3
1HG	7ME3950-5GM00	C1HT1	2HG	7ME3950-5GM20	C1HT2	6JL	7ME3950-5LE00	D3
1HH	7ME3950-5GN00	C2HT1	2HH	7ME3950-5GN20	C2HT2	6JM	7ME3950-5LE00	D3
1HJ	7ME3950-5GP00	D1HT1	2HJ	7ME3950-5GP20	D1HT2	6KK	7ME3950-5LF00	E2
1HK	7ME3950-5GQ00	D2HT1	2HK	7ME3950-5GQ20	D2HT2	6KL	7ME3950-5LF00	E2
1HL	7ME3950-5GR00	D4HT1	2HL	7ME3950-5GR20	D4HT2	6KM	7ME3950-5LF00	E2
1JG	7ME3950-5GM00	C1HT1	2JG	7ME3950-5GM20	C1HT2	6LM	7ME3950-5LF00	E2
1JH	7ME3950-5GN00	C2HT1	2JH	7ME3950-5GN20	C2HT2			
1JJ	7ME3950-5GP00	D1HT1	2JJ	7ME3950-5GP20	D1HT2			
1JK	7ME3950-5GQ00	D2HT1	2JK	7ME3950-5GQ20	D2HT2			
1JL	7ME3950-5GR00	D4HT1	2JL	7ME3950-5GR20	D4HT2			
1KH	7ME3950-5GN00	C2HT1	2KH	7ME3950-5GN20	C2HT2			
1KJ	7ME3950-5GP00	D1HT1	2KJ	7ME3950-5GP20	D1HT2			
1KK	7ME3950-5GQ00	D2HT1	2KK	7ME3950-5GQ20	D2HT2			
1KL	7ME3950-5GR00	D4HT1	2KL	7ME3950-5GR20	D4HT2			
1LJ	7ME3950-5GP00	D1HT1	2LJ	7ME3950-5GP20	D1HT2			
1LK	7ME3950-5GQ00	D2HT1	2LK	7ME3950-5GQ20	D2HT2			
1LL	7ME3950-5GR00	D4HT1	2LL	7ME3950-5GR20	D4HT2			



Ultrasonic flowmeter SITRANS FS230 - Accessories/Spare parts

Other (Univ)			Other (VH)		
Data place 8,9,10 of 7ME372-... combination	Sensor part number	Sensor Size Code	Data place 8,9,10 of 7ME372-... combination	Sensor part number	Sensor Size Code
7BB	7ME3950-5LB01	A2	8BB	7ME3950-5LA13	1
7BC	7ME3950-5LB01	A2	8BC	7ME3950-5LA13	1
7BD	7ME3950-5LB01	A2	8BD	7ME3950-5LA13	1
7BE	7ME3950-5LB01	A2	8BE	7ME3950-5LA13	1
7BF	7ME3950-5LB01	A2	8BF	7ME3950-5LA13	1
7CB	7ME3950-5LB01	A2	8CB	7ME3950-5LA13	1
7CC	7ME3950-5LB01	A2	8CC	7ME3950-5LA13	1
7CD	7ME3950-5LB01	A2	8CD	7ME3950-5LA13	1
7CE	7ME3950-5LB01	A2	8CE	7ME3950-5LA13	1
7CF	7ME3950-5LB01	A2	8CF	7ME3950-5LA13	1
7CG	7ME3950-5LB01	A2	8CG	7ME3950-5LA13	1
7DB	7ME3950-5LC01	B3	8DB	7ME3950-5LA13	1
7DC	7ME3950-5LC01	B3	8DC	7ME3950-5LA13	1
7DD	7ME3950-5LC01	B3	8DD	7ME3950-5LA13	1
7DE	7ME3950-5LC01	B3	8DE	7ME3950-5LA13	1
7DF	7ME3950-5LC01	B3	8DF	7ME3950-5LA13	1
7DG	7ME3950-5LC01	B3	8DG	7ME3950-5LA13	1
7DH	7ME3950-5LC01	B3	8DH	7ME3950-5LA13	1
7EB	7ME3950-5LC01	B3	8EB	7ME3950-5LA13	1
7EC	7ME3950-5LC01	B3	8EC	7ME3950-5LA13	1
7ED	7ME3950-5LC01	B3	8ED	7ME3950-5LA13	1
7EE	7ME3950-5LC01	B3	8EE	7ME3950-5LA13	1
7EF	7ME3950-5LC01	B3	8EF	7ME3950-5LA13	1
7EG	7ME3950-5LC01	B3	8EG	7ME3950-5LA13	1
7EH	7ME3950-5LC01	B3	8EH	7ME3950-5LA13	1
7EJ	7ME3950-5LC01	B3	8EJ	7ME3950-5LA13	1
7EK	7ME3950-5LC01	B3	8EK	7ME3950-5LA13	1
7FC	7ME3950-5LD00	C3	8FC	7ME3950-5LA23	2
7FD	7ME3950-5LD00	C3	8FD	7ME3950-5LA23	2
7FE	7ME3950-5LD00	C3	8FE	7ME3950-5LA23	2
7FF	7ME3950-5LD00	C3	8FF	7ME3950-5LA23	2
7FG	7ME3950-5LD00	C3	8FG	7ME3950-5LA23	2
7FH	7ME3950-5LD00	C3	8FH	7ME3950-5LA23	2
7FJ	7ME3950-5LD00	C3	8FJ	7ME3950-5LA23	2
7FK	7ME3950-5LD00	C3	8FK	7ME3950-5LA23	2
7GD	7ME3950-5LD00	C3	8GD	7ME3950-5LA23	2
7GE	7ME3950-5LD00	C3	8GE	7ME3950-5LA23	2
7GF	7ME3950-5LD00	C3	8GF	7ME3950-5LA23	2
7GG	7ME3950-5LD00	C3	8GG	7ME3950-5LA23	2
7GH	7ME3950-5LD00	C3	8GH	7ME3950-5LA23	2
7GJ	7ME3950-5LD00	C3	8GJ	7ME3950-5LA23	2
7GK	7ME3950-5LD00	C3	8GK	7ME3950-5LA23	2
7GL	7ME3950-5LD00	C3	8GL	7ME3950-5LA23	2
7HE	7ME3950-5LE00	D3	8HE	7ME3950-5LA43	3
7HF	7ME3950-5LE00	D3	8HF	7ME3950-5LA43	3
7HG	7ME3950-5LE00	D3	8HG	7ME3950-5LA43	3
7HH	7ME3950-5LE00	D3	8HH	7ME3950-5LA43	3
7HJ	7ME3950-5LE00	D3	8HJ	7ME3950-5LA43	3
7HK	7ME3950-5LE00	D3	8HK	7ME3950-5LA43	3
7HL	7ME3950-5LE00	D3	8HL	7ME3950-5LA43	3
7HM	7ME3950-5LE00	D3	8HM	7ME3950-5LA43	3
7JG	7ME3950-5LE00	D3	8JG	7ME3950-5LA43	3
7JH	7ME3950-5LE00	D3	8JH	7ME3950-5LA43	3
7JJ	7ME3950-5LE00	D3	8JJ	7ME3950-5LA43	3
7JK	7ME3950-5LE00	D3	8JK	7ME3950-5LA43	3
7JL	7ME3950-5LE00	D3	8JL	7ME3950-5LA43	3
7JM	7ME3950-5LE00	D3	8JM	7ME3950-5LA43	3
7KH	7ME3950-5LF00	E2	8KH	7ME3950-5LA73	4
7KJ	7ME3950-5LF00	E2	8KJ	7ME3950-5LA73	4
7KK	7ME3950-5LF00	E2	8KK	7ME3950-5LA73	4
7KL	7ME3950-5LF00	E2	8KL	7ME3950-5LA73	4
7KM	7ME3950-5LF00	E2	8KM	7ME3950-5LA73	4
7LJ	7ME3950-5LF00	E2	8LJ	7ME3950-5LA73	4
7LK	7ME3950-5LF00	E2	8LK	7ME3950-5LA73	4
7LL	7ME3950-5LF00	E2	8LL	7ME3950-5LA73	4
7LM	7ME3950-5LF00	E2	8LM	7ME3950-5LA73	4



Flow Measurement

SITRANS F S Clamp-on

Ultrasonic flowmeter SITRANS FS230 - Accessories/Spare parts

Selection and Ordering data	Article No.	Selection and Ordering data	Article No.
<i>Spare parts (system)</i>		<i>Spare parts (system)</i>	
SITRANS FS230 IP65/IP66 (NEMA 4X)	7ME 3 9 5 0 - 	SITRANS FS230 IP65/IP66 (NEMA 4X)	7ME 3 9 5 0 - 
Approvals		High temperature universal liquid sensors	
All, FM/FMc, ATEX, IECEX - Flow sensors	5	Very high temperature up to 230 °C (446 °F)	
All, FM/FMc, ATEX, IECEX - Temperature sensors	1	• Size 1 (Ø 12.7 ... 100 mm (0.47 ... 3.94"))	5 LA 1 3
Spare sensor code		• Size 2 (Ø 30 ... 200 mm (1.18 ... 7.87"))	5 LA 2 3
For liquid flow sensors pipe ranges please refer to catalog sensor selection chart in the FSS200 section		• Size 2A (Ø 30 ... 200 mm (1.18 ... 7.87"))	5 LA 3 3
Flow sensors for use with mounting frames or tracks		• Size 3 (Ø 150 ... 610 mm (5.9 ... 24.0"))	5 LA 4 3
Suitable for pipes other than steel or stainless steel.		• Size 3A (Ø 150 ... 610 mm (5.9 ... 24.0"))	5 LA 6 3
Temperature -40 ... +121 °C (-40 ... +250 °F)		• Size 4 (Ø 400 ... 1200 mm (16.75 ... 47.24"))	5 LA 7 3
• A1 Universal	5 LB 1 1	• Size 4A (Ø 400 ... 1200 mm (16.75 ... 47.24"))	5 LA 8 3
• A2 Universal	5 LB 0 1	Standard RTD temperature sensors	
• B1 Universal	5 LC 1 1	Standard clamp-on RTD	1 TA 0 0
• B2 Universal	5 LC 2 1	Submersible clamp-on RTD	1 TB 0 0
• B3 Universal	5 LC 0 1	Insertion style RTD (size 1), 140 mm (5.5")	1 TJ 0 0
• C1 Universal	5 LD 1 0	Insertion style RTD (size 2), 216 mm (8.5")	1 TJ 0 1
• C2 Universal	5 LD 2 0	Insertion style RTD (size 3), 292 mm (11.5")	1 TJ 0 2
• C3 Universal	5 LD 0 0	Insertion style RTD (size 4), 368 mm (14.5")	1 TJ 0 3
• D1 Universal	5 LE 1 0		
• D2 Universal	5 LE 2 0		
• D3 Universal	5 LE 0 0		
• E1 Universal	5 LF 1 0		
• E2 Universal	5 LF 0 0		
• E3 Universal	5 LF 2 0		
Gas and liquid sensors for use with mounting frames or tracks			
Suitable for steel or stainless steel pipes			
Temperature T1			
• A1H high precision	5 LG 0 1		
• A2H high precision	5 LH 0 1		
• A3H high precision	5 LJ 0 1		
• B1H high precision	5 GK 0 1		
• B2H high precision	5 GL 0 1		
• B3H high precision	5 GT 0 1		
• C1H high precision	5 GM 0 0		
• C2H high precision	5 GN 0 0		
• D1H high precision	5 GP 0 0		
• D2H high precision	5 GQ 0 0		
• D3H high precision	5 GU 0 0		
• D4H high precision	5 GR 0 0		
Temperature T2			
• A1H high precision	5 LG 2 1		
• A2H high precision	5 LH 2 1		
• A3H high precision	5 LJ 2 1		
• B1H high precision	5 GK 2 1		
• B2H high precision	5 GL 2 1		
• B3H high precision	5 GT 2 1		
• C1H high precision	5 GM 2 0		
• C2H high precision	5 GN 2 0		
• D1H high precision	5 GP 2 0		
• D2H high precision	5 GQ 2 0		
• D3H high precision	5 GU 2 0		
• D4H high precision	5 GR 2 0		

Ultrasonic flowmeter SITRANS FS230 - Accessories/Spare parts

Selection and Ordering data	Article No.	Selection and Ordering data	Article No.
Spare parts (Miscellaneous)		Spare parts (Miscellaneous)	
SITRANS F S Clamp-on	7ME3960 - 	SITRANS F S Clamp-on	7ME3960 - 
➤ Click on the Article No. for the online configuration in the PIA Life Cycle Portal.			
FS230 dedicated sensor mounting hardware		Sensor mounting tracks (aluminum with mounting straps) for pipes < 125 mm (5 inch)	
Sensor mounting frames for		Universal sensor size A or B	0MA00
• Universal sensor size B (for pipes > 125 mm (5 inch))	CQO:1012FN-PB	High precision sensor size A or B	0MB00
• Universal sensor size C	0MC00	Stainless mounting tracks for high temperature 991 sensors	
• Universal sensor size D	0MC01	Size 1 high temperature sensor pair	CQO: 992MTNHMSH-1
• Universal sensor size E	0MC01	Size 2 high temperature sensor pair	CQO: 992MTNHMSH-2
• High precision sensor size B (For pipes > 125 mm (5 inch))	CQO:1012FNH-PB	Size 3 high temperature sensor pair	CQO: 992MTNHMSH-3
• High precision sensor size C	0MD00	Size 4 high temperature sensor pair	CQO: 992MTNHMSH-4
• High precision sensor size D	0MD01	Clamp-on RTD mounting hardware for dedicated systems	
• Magnetic mounting frames for size C, D, E, universal and high precision sensors	0MD02	RTD mounting hardware for dedicated system	
Spacer bars (for indexing sensors on pipe)		• 1152 ... 610 mm (6 ... 24")	0MR00
Spacer bar for pipes to 200 mm/8 inch (liquid), 600 mm/24 inch (gas)	0MS10	• 12.7 ... 50.8 mm (0.5 ... 2")	0MR01
Spacer bar for pipes to 500 mm/20 inch (liquid), DN 1200/48 inch (gas)	0MS20	• 31.8 ... 203.2 mm (1.25 ... 8")	0MR02
Spacer bar for pipes to 800 mm/32 inch (liquid)	0MS30	• 508 ... 1219 mm (20 ... 48")	0MR04
Spacer bar for pipes to 1200 mm/48 inch (liquid). Must be used with 7ME39600SM30	0MS40	Junction box for clamp on RTD's	CQO:992ECJ
Mounting straps (slotted stainless steel)		Insert RTD thermowells	
For pipes		Thermowell standard duty	
DN 50 ... DN 150	0SM00	• Uninsulated pipe 140 mm (5.5")	CQO:1012TW-1
DN 50 ... DN 300	0SM10	• Uninsulated pipe 216 mm (8.5")	CQO:1012TW-2
DN 300 ... DN 600	0SM20	• Uninsulated pipe: 292 mm (11.5")	CQO:1012TW-3
DN 600 ... DN 1200	0SM30	• With lagging 140 mm (5.5")	CQO:1012TW-1L
DN 1200 ... DN 1500	0SM40	• With lagging 216 mm (8.5")	CQO:1012TW-2L
DN 1500 ... DN 2100	0SM50	• With lagging 292 mm (11.5")	CQO:1012TW-3L
DN 2100 ... DN 3000	0SM60	Sensor cables	
High precision mounting enclosures for sensors		Coax (CE mark)	
Stainless steel mounts for high precision size "C" sensors, single enclosure	0WS50	• 10 m (32.8 ft) armored sensor cable pair with nickel plated brass glands	A5E38028474004
Stainless steel mounts for high precision size "D/E" sensors, single enclosure	0WS60	• 20 m (65.6 ft) armored sensor cable pair with nickel plated brass glands	A5E38028474005
Stainless steel mounts for high precision size "C" sensors, dual enclosure	0WD50	• 10 m (32.8 ft) standard/submersible Coax sensor cable pair with Nylon glands	A5E39669934004
Stainless steel mounts for high precision size "D/E" sensors, dual enclosure	0WD60	• 20 m (65.6 ft) standard/submersible Coax sensor cable pair with Nylon glands	A5E39669934005
Stainless steel bands for high precision mounting enclosures		• 10 m (32.8 ft) standard/submersible Coax sensor cable pair with nickel plated brass glands	A5E39669934009
Mounting strap for pipe diameter to		• 20 m (65.6 ft) standard/submersible Coax sensor cable pair with nickel plated brass glands	A5E39669934010
• 300 mm (13")	0SM01	• 10 m (32.8 ft) standard/submersible Coax sensor cable pair with stainless steel glands	A5E39669934014
• 600 mm (24")	0SM11	• 20 m (65.6 ft) standard/submersible Coax sensor cable pair with stainless steel glands	A5E39669934015
• 1200 mm (48")	0SM21	• 20 m (65.6 ft) plenum rated Coax sensor cable pair with Nylon glands	A5E39669934020
• 1500 mm (60")	0SM31	• 20 m (65.6 ft) plenum rated Coax sensor cable pair with nickel plated brass glands	A5E39669934025
• 2130 mm (84")	0SM41	• 20 m (65.6 ft) plenum rated Coax sensor cable pair with stainless steel glands	A5E39669934030
• 3050 mm (120")	0SM51		
• 5486 mm (216")	0SM61		
ADAPTER, MTG STRAP, TEMP COMP	CQO-1012WSM-A2		

Flow Measurement

SITRANS F S Clamp-on

Ultrasonic flowmeter SITRANS FS230 - Accessories/Spare parts

Selection and Ordering data	Article No.	Selection and Ordering data	Article No.
<i>Spare parts (Miscellaneous)</i>		<i>Spare parts (Miscellaneous)</i>	
SITRANS F S Clamp-on	7ME 3 9 6 0 -	SITRANS F S Clamp-on	7ME 3 9 6 0 -
Cable glands and adapters		Universal sensor test blocks	
Cable gland set M20, nylon	A5E38145321	Test block for size A and B universal sensors	0 T B 1 0
Cable gland set M20, nickel/brass	A5E38145323	Test block for size C and D universal sensors	0 T B 2 0
Cable gland set M20, stainless steel	A5E38145327		
Iris glands, set of 2, nickel plated brass	A5E38635890	Thickness gauge	
Iris glands, set of 2, stainless steel	A5E38635986	Stand alone thickness gauge	7ME39510TG20
M20xNPT adapters, set of 8, brass/nickel	A5E38145635		
M20xNPT adapters, set of 8, brass/nickel, Ex	A5E38309159		
M20xNPT adapters, set of 8, stainless steel	A5E38145643		
RTD temperature sensor cables			
6 m (20 ft) standard RTD cable	0 C R 5 0		
15 m (50 ft) standard RTD cable	0 C R 5 1		
30 m (100 ft) standard RTD cable	0 C R 5 2		
46 m (150 ft) standard RTD cable	0 C R 5 3		
61 m (200 ft) standard RTD cable	0 C R 5 4		
91 m (300 ft) standard RTD cable	0 C R 5 5		
6 m (20 ft) submersible RTD cable	0 C R 5 6		
15 m (50 ft) submersible RTD cable	0 C R 5 7		
30 m (100 ft) submersible RTD cable	0 C R 5 8		
46 m (150 ft) submersible RTD cable	0 C R 5 9		
61 m (200 ft) submersible RTD cable	0 C R 6 0		
91 m (300 ft) submersible RTD cable	0 C R 6 1		
Dedicated cable termination kits for:			
Standard, plenum sensor cable (NEMA 4X and NEMA 7 wall)	0 C T 0 1		
Submersible sensor cable (NEMA 4X and NEMA 7 wall)	0 C T 1 1		
Clamp-on RTD cable termination kit for standard RTD	0 C T 2 1		
Clamp-on RTD cable termination kit for submersible RTD	0 C T 3 1		
Insert RTD cable termination kit	0 C T 4 1		
Termination kit for armored cable	CQO:1012CNFX-TK		
Ultrasonic couplants			
Temporary water based for portable systems: 350 ml (12 oz): -34 ... +38 °C (-30 ... +100 °F)	0 U C 1 0		
Permanent synthetic polymer based: 90 ml (3 oz) -40 ... +190 °C (-40 ... +375 °F)	0 U C 1 0		
Dry coupling pad kit (10 pieces)	0 U C 1 0		
Permanent high temperature fluoroether: 163 ml (5.5 oz): -40 ... +230 °C (-40 ... +450 °F)	0 U C 1 0		
Permanent vulcanizing silicone rubber couplant: 90 ml (3 oz): -40...+120C (-40...+250 °F)	CQO:CC112		
Permanent high temperature silicone grease: 12 ml (0.4 oz): -40 ... +230 °C (-40 ... +450 °F)	CQO:CC117B		
Permanent high temperature silicone grease: 150 ml (5 oz): -40 ... +230 °C (-40 ... +450 °F)	CQO:CC117A		
Couplant for submersible sensor applications	CQO:CC120		
Pipe damping films			
B1, B2, B3, C1 and C2 sensors	0 D M 1 0		
D1 and D3 sensors	0 D M 2 0		
D2 sensor	0 D M 3 0		
D4 sensor	0 D M 4 0		