



District heating controller

RVD260

for 2 heating circuits and d.h.w., communicating

Multifunctional heating controller for district heat transfer stations and plants with LPB and M-bus communication. Suited for the control of 2 heating circuits with d.h.w. heating in instantaneous systems or with d.h.w. storage tank. 14 programmed plant types. Operating voltage AC 230 V.

Use

- Types of plants:
 - Autonomous heating groups with own d.h.w. heating system, with connection to a district heat transfer station
 - Interconnected plants consisting of several heating groups each with 2 independent heating circuits and d.h.w. heating system; in a district heat transfer station
- Types of buildings:
Residential and nonresidential buildings with own district heat connection and d.h.w. heating system
- Types of heating systems:
All types of standard heating systems, such as radiator, convector, underfloor and ceiling heating systems, including radiant panels
- Types of d.h.w. heating systems:
 - D.h.w. heating with storage tank or in instantaneous systems
 - Common or separate heat exchangers for heating circuits and d.h.w. heating
 - D.h.w. heating with electric immersion heater and solar collector

Functions

Heating circuit control

- Weather-compensated flow temperature control, mixing valve with 3-position actuator
- Weather-compensated flow temperature control with room influence, mixing valve with 3-position actuator
- Room-compensated flow temperature control, mixing valve with 3-position actuator
- Demand-dependent control of the common flow temperature

D.h.w. control

- D.h.w. heating with coil type storage tanks, with or without mixing valve in the secondary circuit
- D.h.w. heating with stratification storage tanks
- Direct d.h.w. heating off heat exchanger
- D.h.w. heating with electric immersion heater and solar collector

Other functions

- Optimized heating up and setback
- Automatic heating limit (automatic ECO function)
- Frost protection (for the building, plant, and d.h.w.)
- 365-day clock with automatic summer- / wintertime changeover
- Independent time programs for heating circuits and d.h.w. heating
- Adjustable heating period
- Maximum limitation of flow temperature rise and flow alarm
- Analog (DC 0...10 V) and digital input
- PWM output for speed-controlled pump
- Communication via LPB (Local Process Bus) and M-bus
- Pump and valve kick
- Cooling down protection in the case of direct d.h.w. heating off parallel heat exchanger
- Flow switch with adjustable load limit, seasonal adaptation and child-proofing
- Differential temperature limitation for the heat exchanger (DRT function)
- Minimum limitation of the flow rate for suppression of hydraulic creep
- Relay and sensor test
- Remote control with room units
- Refill function

Type summary

<i>Description</i>	<i>Instructions in ...</i>	<i>Product no.</i>	<i>Order number</i>
District heating and d.h.w. controller	German, French, English, Italian, Danish, Finnish, Swedish Polish, Czech, Greek, Russian, Bulgarian, Romanian	RVD260-A	S55370-C129

Ordering

Note Sensors, room units, actuators and valves must be ordered as separate items.

Equipment combinations

Suitable sensors and room units

- Flow, return and d.h.w. temperature:
All sensors with sensing element LG-Ni1000, e.g.:
 - Strap-on sensor QAD22
 - Immersion sensors QAE212... and QAP21.3
 - Collector sensor QAP21.2 (solar)
- Room temperature:
 - Room units (PPS) QAA50.110/101 and QAW70 (both addressable)
If a room unit or room sensor is used in both heating circuits, one of the 2 devices must be addressable. This means:
 - The first unit can be a QAA50.110/101 or QAW70
 - The second unit must be a QAA50.110/101 or QAW70
- Outside temperature:
 - Outside sensor QAC22 (sensing element LG-Ni1000)
 - Outside sensor QAC32 (sensing element NTC 575)
- Pressure: Sensor delivering DC 0...10 V signals, e.g.
 - Pressure sensor QBE2002...

Note The RVD260 controller automatically identifies the type of sensor used.

Suitable actuators

All types of Siemens electromotoric and electrohydraulic actuators for 3-position control operating on AC 24...230 V can be used.
With d.h.w. applications, consideration must be given to actuator running times and sensor time constants. For detailed information, refer to the Basic Documentation.
For detailed information about actuators and valves, refer to the respective Data Sheets.

Product documentation

<i>Type of document</i>	<i>Document no.</i>	<i>Stock number</i>
Operating Instructions Language set: de, en, fr, it, da, fi, sv	B2515	74 319 0728 0
Operating Instructions Language set: pl, cs, el, ru, bg, ro	B2515	74 319 0729 0
Installation Instructions, Language set: de, en, fr, it, da, fi, sv	G2515	74 319 0726 0
Installation Instructions, Language set: pl, cs, el, ru, bg, ro	G2515	74 319 0727 0
Basic Documentation	P2515	STEP Web Client
CE Declaration of Conformity	T2513	STEP Web Client
Environmental Declaration	E2513	STEP Web Client

Technical design

Functioning

The RVD260 controller allows the configuration of 14 different plant types as combinations of heating circuit and d.h.w. heating system.
When commissioning a plant, the relevant plant type must be selected and entered. All required functions, settings and displays are then automatically assigned, and parameters that are not required will be hidden.

Note Optional functions are to be configured in addition to the standard functions.

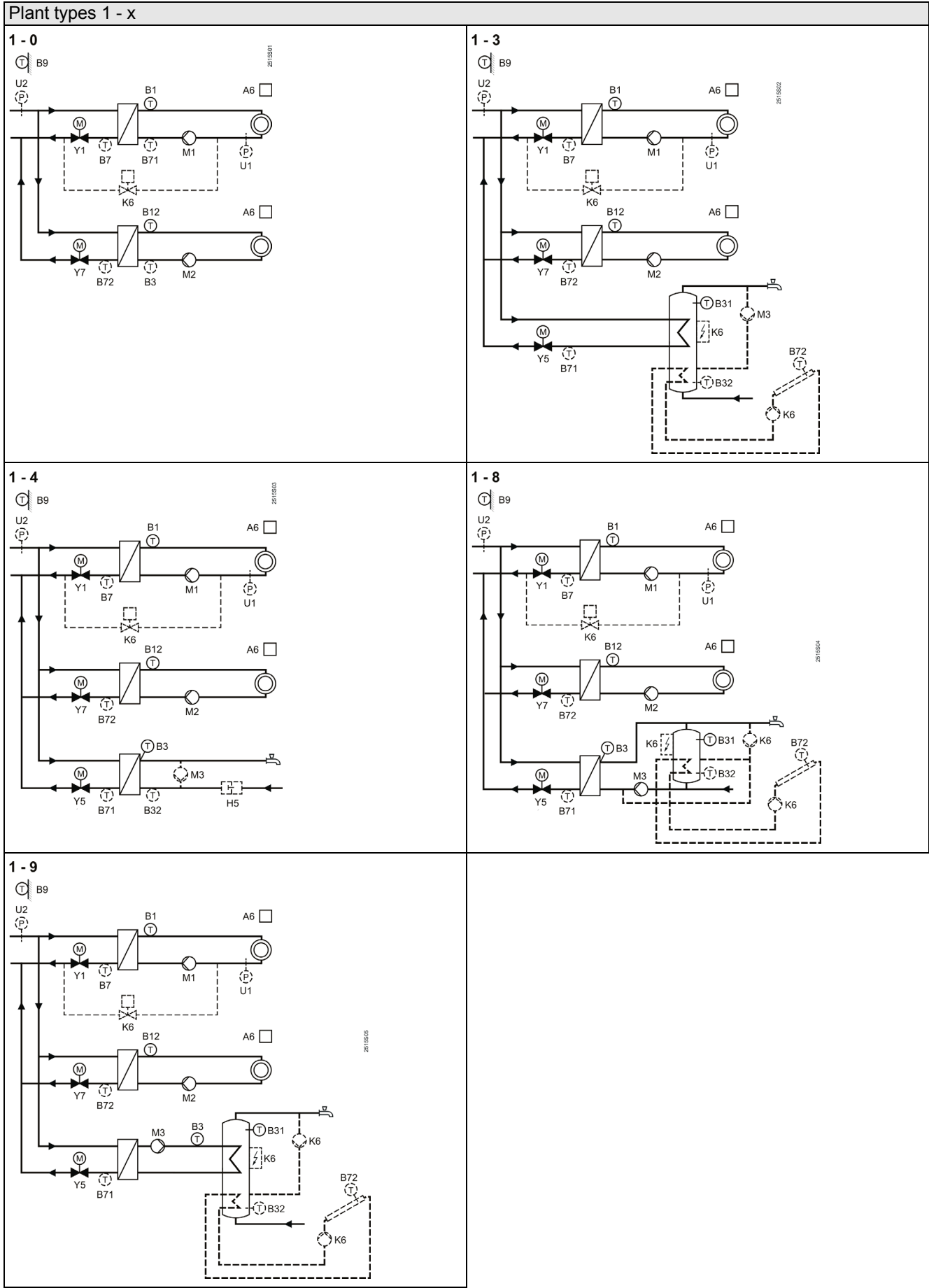

Plant types 2 - x

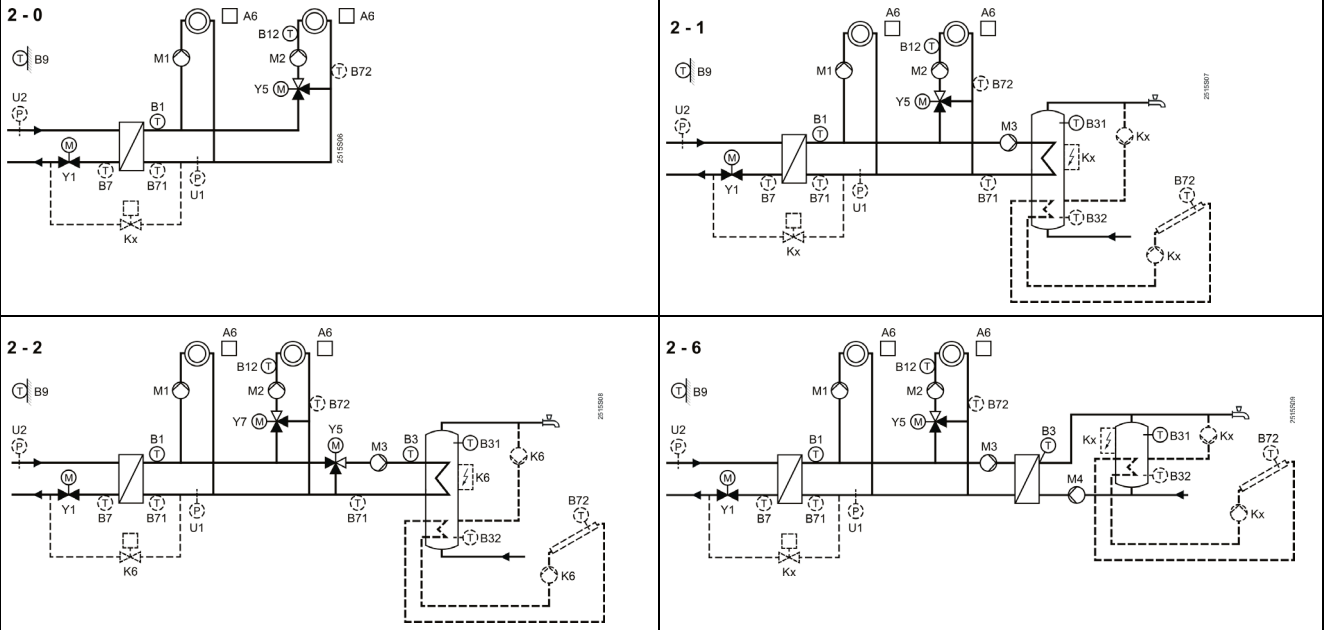



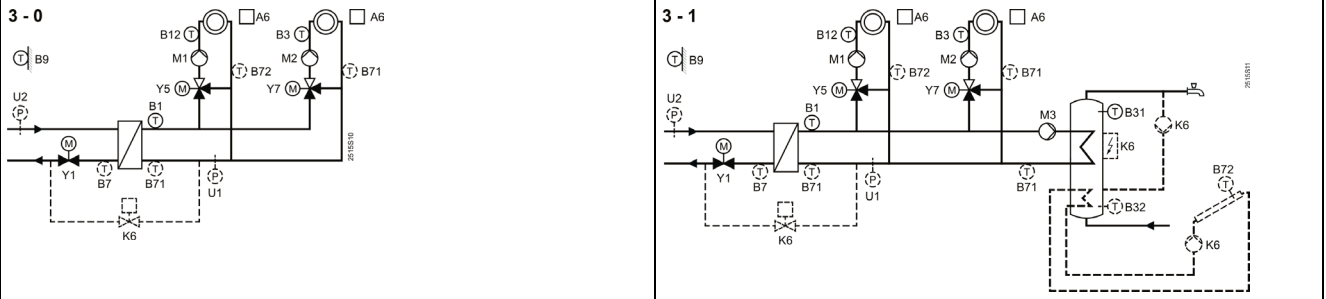

Plant types 3 - x

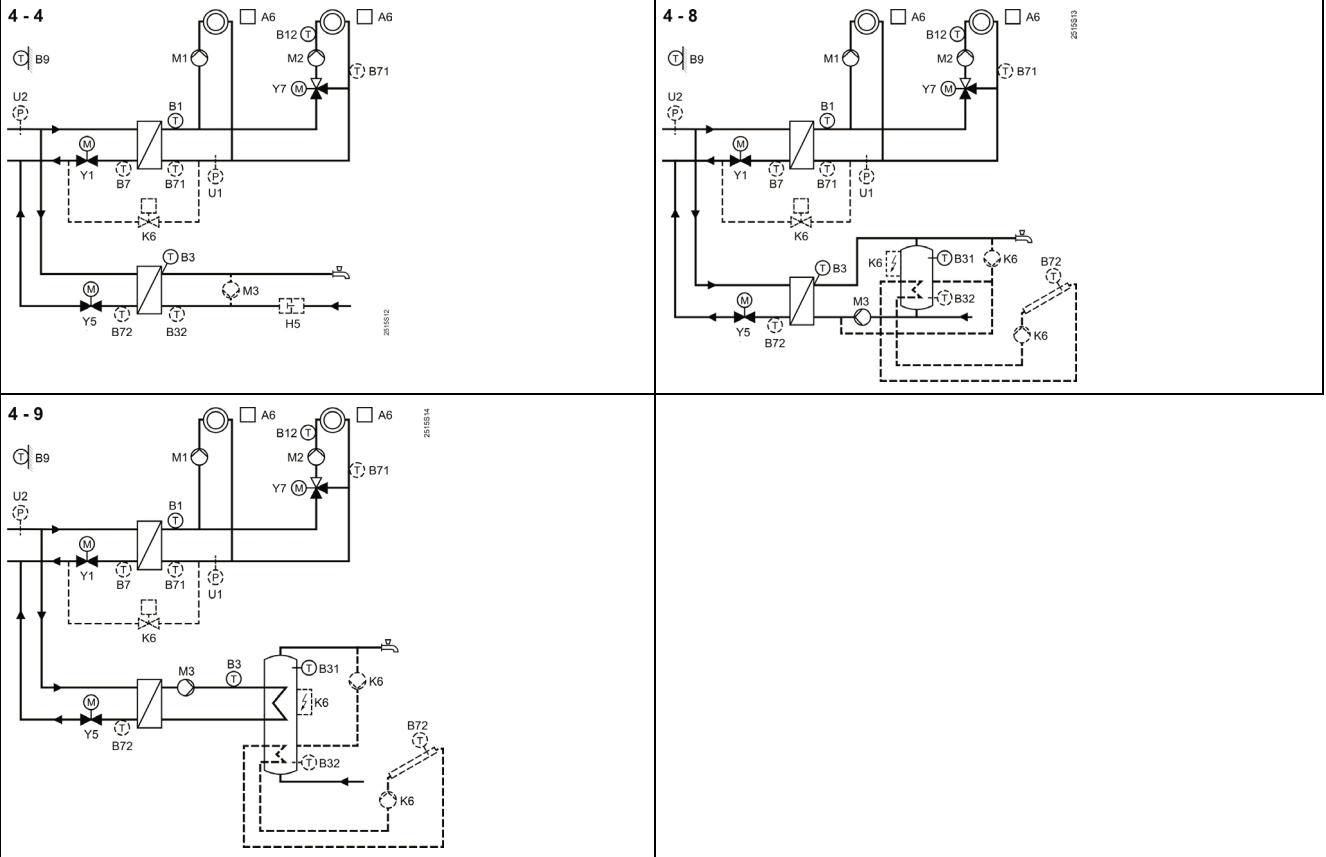

Plant types 4 - x



Operating modes	<p>Auto  Automatic operation Automatic heating according to the time program; automatic ECO function and room unit active.</p> <p> Continuous operation Heating without time program, setpoint according to the setting knob.</p> <p> Protection Heating off, frost protection ensured.</p> <p> Automatic d.h.w. heating</p> <p> Manual control No control, pumps in operation.</p>
Notes	<ul style="list-style-type: none"> • Frost protection is ensured in all operating modes • The operating mode of the heating circuit has no impact on d.h.w. heating
Heating circuit control	<p>The RVD260 controller provides control of the following heating circuit plant types:</p> <ul style="list-style-type: none"> • 2 pump heating circuits off 2 separate heat exchangers • 2 mixing heating circuits off a common heat exchanger • 1 pump and 1 mixing heating circuit off a common heat exchanger
Compensating variables	<p>With weather-compensated control, the composite outside temperature is used as the compensating variable. It is calculated (by the controller) from the current and the attenuated outside temperature. The building time constant is adjustable.</p>
Setpoints	<p>Adjustable are the setpoints for the nominal room temperature, the reduced room temperature, and the room temperature for frost protection.</p>
Generation of the flow temperature setpoint	<p>The assigned flow temperature setpoint is generated as follows:</p> <ul style="list-style-type: none"> • For weather-compensated control: The setpoint is continuously determined by the outside temperature. The assignment of the flow temperature to the outside temperature is made by the heating curve • For weather-compensated control with room influence: The setpoint is determined by the outside temperature and, in addition, by the deviation of room temperature setpoint and actual value • For room-compensated control: The setpoint is determined by the room temperature deviation of setpoint and actual value <p>A maximum limitation can be set for limiting the rate the flow temperature setpoint increases. Also, a flow alarm is used; the period of time the flow temperature is allowed to remain outside a defined setpoint range can be set. When this period of time has elapsed, an error message is delivered.</p>
Heating circuit control	<p>The control variable for the heating circuit is the secondary flow temperature. With all plant types, control is effected via the 2-port valve in the primary return, depending on the plant's total demand for heat (heating circuits and d.h.w. circuit).</p>
Maximum limitation of the return temperature	<ul style="list-style-type: none"> • Primary circuit: The valve in the primary circuit is driven toward the FULLY CLOSED position when the limit value is exceeded. The characteristic runs constant-shifting-constant, depending on the outside temperature • Secondary circuit: The valve in the secondary circuit is driven toward the FULLY CLOSED position when the limit value is exceeded. The difference to the primary circuit's limit value must be set

Heating curve

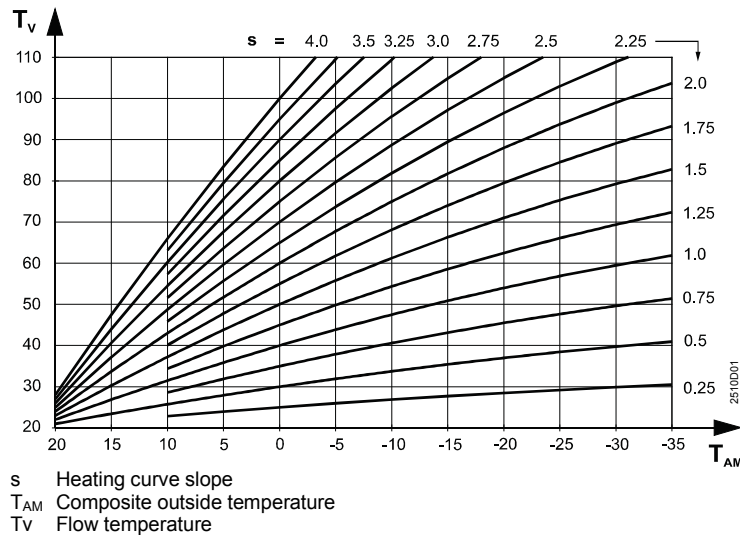

Optimization

Control is optimized; switching on and heating up as well as switching off are controlled such that during occupancy periods the required room temperature is always maintained.

At the end of each occupancy period, the heating is switched off (circulating pump) until the room temperature setpoint for nonoccupancy periods is reached (quick setback, can be deactivated).

Maximum limit values for the heating up time and for early shutdown can be set.

The optimization functions can be deactivated.

Automatic ECO function

The automatic ECO function controls the heating system depending on demand; it is deactivated if permitted by the progression of the outside temperature. For that, consideration is given to the current, the attenuated and the composite outside temperature, as well as an adjustable heating limit.

The automatic ECO function requires an outside sensor. The function can be deactivated, if required.

Maximum and minimum limitation of the flow temperature

Both limitations are effected via the heating curve; at the limit value, the heating curve changes to a constant value. Active limitations are shown on the display. Both limitations can be deactivated.

DRT function

For the differential of primary and secondary return temperature, a maximum limitation can be set.

Pump and valve kick.

A kick can be activated for all pumps and valves, aimed at preventing them from seizing. The kick lasts 30 seconds and is made once a week.

Relay and sensor test

To facilitate commissioning and fault tracing, the controller can perform the tests:

- Relay test: Each relay can be manually energized
- Sensor test: The current sensor values can be queried
- Setpoint test: The current setpoints can be queried

Increasing the reduced room temperature

The setpoint of the reduced room temperature can be increased as the outside temperature drops. The rate of increase is adjustable.

This function can be deactivated.

Frost protection for the building

Frost protection for the building ensures that an adjustable minimum room temperature is maintained.

This function cannot be deactivated.

Frost protection for the plant	<p>Frost protection for the plant protects the heating system against freeze-ups by activating the heating circuit pumps. It can be provided with or without outside sensor:</p> <ul style="list-style-type: none"> • With outside sensor: <ul style="list-style-type: none"> Outside temp. ≤ 1.5 °C: Heating circuit pumps run for 10 minutes at 6-hour intervals Outside temp. ≤ -5 °C: Heating circuit pumps run continuously. • Without outside sensor: <ul style="list-style-type: none"> Flow temp. ≤ 10 °C: Heating circuit pumps run for 10 minutes at 6-hour intervals Flow temp. ≤ 5 °C: Heating circuit pumps run continuously <p>This function can be deactivated.</p>
Signal inputs	<ul style="list-style-type: none"> • Analog input for displaying and forwarding DC 0...10 V signals, or for heat demand DC 0...10 V • Digital input for pulses or signals from a flow switch or heat meter, for heat demand or alarms
Suppression of hydraulic creep	<p>Minimum limitation of the flow rate aimed at suppressing hydraulic creep can act on both the heating circuit and the common primary return. The limitation is ensured by an auxiliary switch in the actuator.</p>
Refill function	<p>The RVD260 controller supports the refill function, aimed at maintaining the plant pressure on the secondary side.</p> <p>If the pressure drops below a minimum value, water is fed from the primary side or a separate tank to the plant's circuit on the secondary side to ensure the pressure will increase again.</p>
Heating period	<p>Outside the adjustable heating period, both heating circuits are switched off. The display shows ECO. Switching off takes place in addition to the automatic ECO function and summer- / wintertime changeover.</p> <p>Frost protection for the building and the plant is maintained. This function has no impact on d.h.w. heating.</p>
D.h.w. heating	<p>The RVD260 controller provides d.h.w. control with the following plant types and d.h.w. systems:</p> <ul style="list-style-type: none"> • Stratification storage tank with charging pump and 2 sensors • Coil type storage tank with intermediate circuit pump and 2 sensors, with or without mixing valve in the d.h.w. circuit • Directly off the system's own heat exchanger <p>The heat for the d.h.w. circuit can be supplied either by the system's own heat exchanger or the common flow (heating circuits and d.h.w. circuit).</p>
Settings	<p>The nominal and the reduced setpoint, maximum setpoint, setpoint increase, switching differential, overrun time of charging pump, and the maximum duration of d.h.w. charging are adjustable.</p>
Frost protection for d.h.w.	<p>A minimum d.h.w. temperature of 5 °C is always ensured.</p>
Manual charging	<ul style="list-style-type: none"> • Independent of time program and temperature conditions • During protection of the heating circuits
Limitation	<p>The maximum limitation of the primary return temperature can be adjusted. The adjusted limit value is independent of heating circuit control.</p>

Releases	<p>The release of d.h.w. charging and the circulating pump can be selected:</p> <ul style="list-style-type: none"> • Always (24 hours a day) • According to own d.h.w. time program • During the controller's heating circuit time program (d.h.w. charging with forward shift of first daily release)
Priority	<p>The behavior of the heating circuits during d.h.w. charging can be selected:</p> <ul style="list-style-type: none"> • Absolute: Heating circuit pumps OFF, or heating circuit mixing valve FULLY CLOSED and pumps ON • Shifting: Heating circuit pumps remain ON as long as heat is available. Control to the d.h.w. temperature setpoint or the maximum setpoint • Parallel: No priority; heating circuits remain ON. Control to the d.h.w. temperature setpoint or the maximum setpoint
Cooling down protection	In the case of instantaneous systems, the heat exchanger's primary side is heated up at certain intervals.
Flow switch	To improve the heat exchanger's control performance, with adjustable load limit and for seasonal adaptation and as child-proofing (flow switch prevents control from responding too frequently).
Forced charging	D.h.w. charging takes place daily, always at the time of the first release (or at midnight with the 24-hour program). It is performed also when the actual value lies within the switching differential.
Legionella function	The d.h.w. is heated up at certain intervals to ensure protection against legionella viruses.
Electric immersion heater and solar collector	In the case of plant types with d.h.w. storage tank, the 2 multifunctional relays for d.h.w. heating with electric immersion heater and solar collector can be parameterized.
Note	Availability of the above mentioned functions depends on the type of d.h.w. heating.
Miscellaneous functions	
Time switch programs	<p>For automatic operation, the RVD260 controller has a 7-day program with 3 adjustable heating periods per day. Another 7-day program is available for the release of d.h.w. charging.</p> <p>Using the 365-day clock with automatic summer- / wintertime changeover, a maximum of 8 holiday periods can be programmed. During holiday periods:</p> <ul style="list-style-type: none"> • Heating circuit control is in protection mode and the d.h.w. will not be heated
Remote control with room unit	<ul style="list-style-type: none"> • Room unit QAA50.110/101: Changeover of operating mode, setting the room temperature setpoint, and room temperature readjustment • Room unit QAW70: Overriding setpoints, the heating program and the holiday program • It is possible to use 1 room unit per heating circuit
PWM output	A PWM (pulse width modulation) output is available for the connection of a speed-controlled pump.
Pulse lock for actuators	To reduce wear and tear on the relay contacts, the total duration of the OPEN / CLOSE pulses delivered to an actuator is limited to 5 times its running time.

Communication

- Via LPB, e.g. assignment of d.h.w., master-slave assignments for the time switch, reception of outside temperature signal
- Via M-bus

Manual control

In the case of manual control, the heating can be controlled manually; d.h.w. heating remains activated. The relays are energized / deenergized as follows:

- Actuator driving the primary return valve: Dead, but can be controlled manually from the controller
- Other actuators fully closed, dead
- Heating circuit pumps activated
- Collector pump activated and electric immersion heater released

Mechanical design

Controller

The RVD260 consists of controller insert and base. The controller insert accommodates the electronics, the power section and 10 relays. The front carries the operating elements and the backlit display. The controller insert is secured to the base with 2 screws. The base accommodates the connection terminals.

Display and operating elements

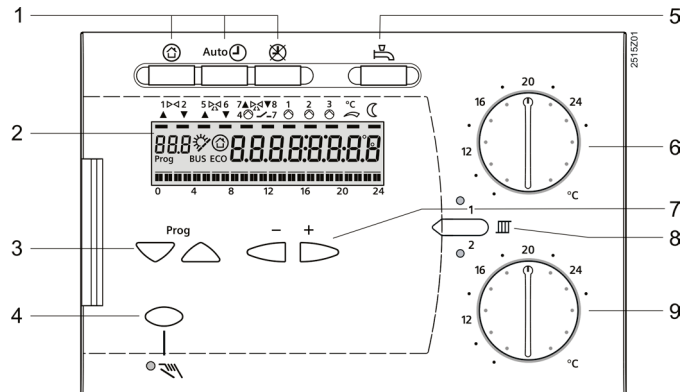

- 1 Buttons for selecting the operating mode
- 2 Display (LCD)
- 3 Buttons for selecting the operating lines
- 4 Button for manual control ON / OFF
- 5 Button for d.h.w. heating ON / OFF
- 6 Setting knob for nominal room temperature setpoint of heating circuit 1
- 7 Buttons for adjusting values
- 8 Button for switching between the heating circuits
- 9 Setting knob for nominal room temperature setpoint of heating circuit 2

Operation

- Operating elements:
 - Setting knob for nominal room temperature setpoint of heating circuit 1
 - Setting knob for nominal room temperature setpoint of heating circuit 2
 - Button for the respective operating mode
 - Button for manual control
 - Button for d.h.w. heating
 - Button for changeover of heating circuits
- The setting and readjustment of all other parameters, the activation of functions and reading actual values and statuses follow the operating line principle. An operating line with a number is assigned to each parameter, each actual value and each function. For selection of the operating lines and the adjustment of values, 2 pairs of buttons (3) and (7) are available.

The enclosed Operating Instructions can be inserted in the rear of the cover.

Notes

Engineering

Electrical installation

- The cables of the measuring circuits carry extra low-voltage
- The cables to the actuator and pumps carry AC 24...230 V
- Local regulations for electrical installations must be complied with
- Sensor cables must not be run parallel to mains carrying cables powering actuators, pumps, etc. (Safety class II conforming to EN 60730)

Radiator valves

In control systems using a room temperature sensor, the reference room must not be equipped with thermostatic radiator valves; manual valves must be locked in their fully open position.

Refill function

When making use of the refill function, the local regulations and those of the district heat utility must be observed.

Lightning protection

- If bus cables are also laid outside buildings, the devices are exposed to transients of lightning strokes and must be appropriately protected
- Every bus cable and the devices to be protected demand matching protective equipment
- Protection is ensured only if the installation is in proper working order
- For notes on installation in compliance with EMC requirements, refer to Data Sheet CE1N2034

Installation

Types of mounting

- Wall mounting (on a wall, in a control panel, etc.)
- Standard mounting rail (top hat rail)
- Flush mounting (cutout in control panel door, etc.)

Mounting location

Suitable mounting locations are control panels, control desks, compact stations, or the heating room. Not permitted are damp or wet spaces.

Connections

All connection terminals for protective extra low-voltage (sensors and room unit bus) are located on the upper terminal block, those for mains voltage (actuators and pumps) on the lower terminal block.

Commissioning

- Selection of plant type
- The settings can be completely or partly disabled on the software side. In addition, the district heat parameters can be disabled on the hardware side
- The controller is supplied complete with Installation, Mounting and Commissioning Instructions
- "Address 2" must be set on the room unit for heating circuit 2

Disposal



The device is considered electrical and electronic equipment for disposal in terms of the applicable European Directive and may not be disposed of as domestic garbage.

- Dispose of the devices through channels provided for this purpose.
- Comply with all local and currently applicable laws and regulations.

Warranty

When using the RVD260 in connection with third-party devices, correct functioning must be ensured by the user. In that case, Siemens will assume no responsibility for service and warranty.

Technical data

Operating voltage	Operating voltage	AC 230 V (+10 / -15%)
	Frequency	50 Hz
	Power consumption (excl. external loads)	Max. 6 VA
	External supply line protection	Slow-blow fuse max. 10 A or Circuit breaker max. 13 A Characteristic B, C, D according to EN 60898
<hr/>		
Inputs		
Sensor inputs (B...)	Sensing elements	Refer to section "Equipment combinations"
<hr/>		
Digital input (H5)	Voltage when contact is open	DC 12 V
	Current when contact is closed	DC 3 mA
	Contact resistance	$R \leq 80 \Omega$
<hr/>		
Analog inputs (U...)	Working range	DC 0...10 V
	Input resistance	$R > 100 \text{ k}\Omega$
<hr/>		
Outputs		
Relay outputs	Voltage	AC 24...230 V
	Current Y1, Y2, Q1, Q2, Q3, K6, Y7/Q4, Y8/K7	AC 0.02...1(1) A
	Current Y5, Y6	AC 0.02...2(2) A
	Switch-on current	Max. 10 A, max. 1 s
	Switching capacity as mixing valve relay	Max. 15 VA
	External supply line protection	See section power supply
<hr/>		
PWM output	Idle voltage	12 V
	Internal resistance	1220 Ω
	Frequency	2,400 Hz
<hr/>		
Interfaces		
LPB	Connection	2-wire (not interchangeable)
	Bus loading number (E)	3
<hr/>		
M-bus	Connection	2-wire (interchangeable)
<hr/>		
PPS	Connection (room unit or room sensor)	2-wire (interchangeable)
<hr/>		
Permissible cable lengths	For all sensors	
	Copper cable 0.6 mm dia.	20 m
	Copper cable 1,0 mm ²	80 m
	Copper cable 1.5 mm ²	120 m
	<hr/>	
	For room units (PPS)	
Copper cable 0,25 mm ²	25 m	
Copper cable from 0.5 mm ²	50 m	
<hr/>		
Electrical connections	Screw terminals	For cross-sectional areas up to 2.5 mm ²
<hr/>		
Backup of time switch	Time of day	12 h
<hr/>		

Standards, directives and approvals	Product standard	EN 60730-1	Automatic electrical controls for household and similar use	
	Electromagnetic compatibility (Applications)		For use in residential, commerce, light-industrial and industrial environments	
	EU conformity (CE)		CE1T2513xx *)	
Environmental compatibility	RCM-conformity (EMC)		CE1T2513en_C1 *)	
	Product environmental declaration (contains data on RoHS compliance, materials composition, packaging, environmental benefit, disposal)		CE1E2513 *)	
Eco design and labeling directives			Class	Efficiency gain
	Application with one room temperature sensor and one outdoor temperature sensor and modulating control		VIII	5.0%

*) The documents can be downloaded from <http://siemens.com/bt/download>.

Classification according to EN 60730	Software class	A
	Mode of operation	1B (automatic operation)

Protection	Safety class	II to EN 60730 (if correctly installed)
	Degree of protection of housing	IP 40 to EN 60529 (if correctly installed)
	Pollution class	2 to EN 60730

Dimensions Refer to "Dimensions"

Weight	Weight (net)	0.85 kg
---------------	--------------	---------

Housing colors	Housing	Light-grey RAL 7035
	Base	Pigeon-blue RAL 5014

Permissible ambient conditions	<i>Operation</i>	<i>Transport</i>	<i>Storage</i>
	<i>EN 60721-3-3</i>	<i>EN 60721-3-2</i>	<i>EN 60721-3-1</i>
Climatic conditions	Class 3K5	Class 2K3	Class 1K3
Temperature	0...50 °C	-25...70 °C	-20...65 °C
Humidity	<95% r.h. (noncondensing)	<95% r.h.	<95% r.h. (noncondensing)
Mechanical conditions	Class 3M2	Class 2M2	Class 1M2
Altitude	Max. 3000 m above sea level		

Connection diagrams

Low voltage side

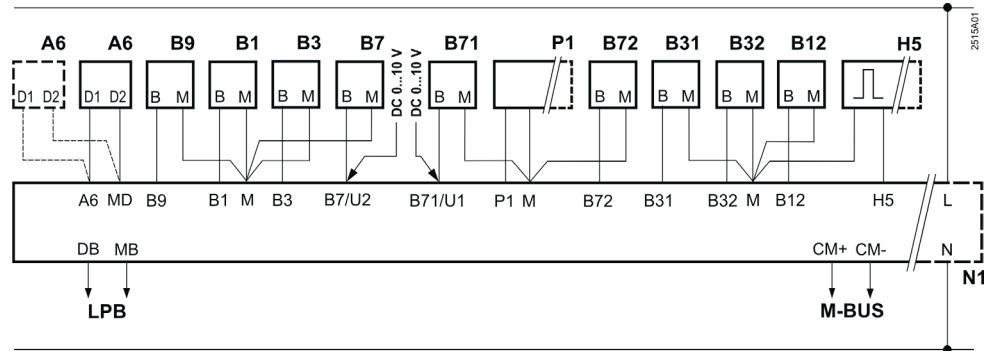

Mains voltage side

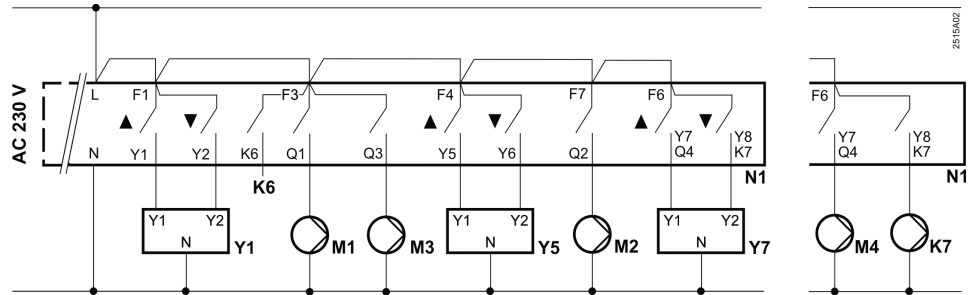

- A6 Room unit
- B1 Flow sensor heating circuit 1 / common flow*
- B12 Flow sensor heating circuit 1 / heating circuit 2*
- B3 Flow sensor d.h.w. / heating circuit 2*
- B31 D.h.w. storage tank sensor
- B32 D.h.w. storage tank sensor / return sensor*
- B7 Primary return sensor**
- B71 Primary / secondary return sensor*
- B72 Primary / secondary return sensor / collector sensor
- B9 Outside sensor
- H5 Heat meter, flow switch, alarm contact, etc.
- Kx K6, K7 = multifunctional outputs for refill function / electric immersion heater / collector pump / circulating pump / flow alarm*
- N1 Controller RVD260
- P1 Speed-controlled pump (PWM output)
- M1 Heating circuit pump
- M2 Heating circuit pump
- M3 D.h.w. intermediate circuit / storage tank charging / circulating pump
- M4 Storage tank charging pump
- U1 Secondary pressure sensor / external heat request
- U2 Primary pressure sensor
- Y1 Actuator of 2-port valve in the primary return
- Y5 Actuator*
- Y7 Actuator*
- * According to plant type
- ** For suppression of hydraulic creep

Dimensions

2515M01

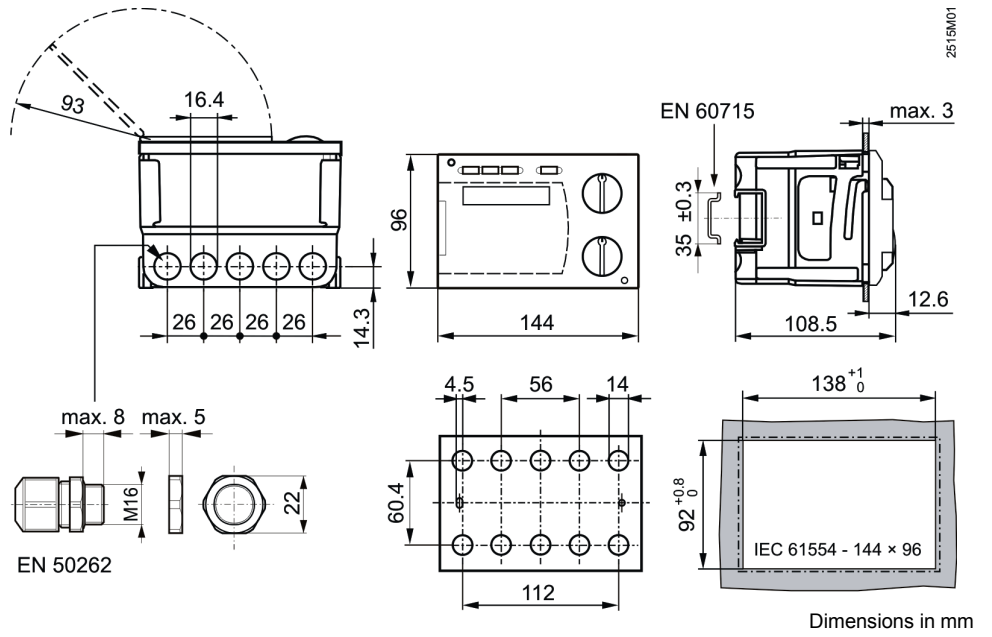

© Siemens Switzerland Ltd 2010
Delivery and technical specifications subject to change

16/16

Siemens
Building Technologies

District heating controller RVD260

CE1N2515en
2018-04-16

A.P.O. - ELMOS v.o.s., Pražská 90, 509 01 Nová Paka, Tel.: +420 493 504 261, E-mail: apo@apoelmos.cz, Internet: www.apoelmos.cz