

SPECIFICATION







FLUID	: Air filtered, lubricated or not
PORTS	: instant fittings for Ø 4 mm OD tube or G 1/8
PRESSURE	: 0,1 to 8 bar
TEMPERATURE	: -5°C to +50°C
FLOW (Qv at 6 bar)	: 140 l/min (ANR)
Ø NOMINAL	: 2,5 mm
OPERATING HEADS	: Mechanical
IMPLANTING	: CENELEC EN 50047 CNOMO n° 06.05.35

CONSTRUCTION

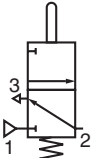
Centre closed poppet valve
Body diecast
Internal parts in stainless steel and elastomer
Built-in exhaust silencer (exhaust port can be piped G 1/8)
Instant fittings brass



CHOICE OF EQUIPMENT

FUNCTION NC Normally closed				 1 = Pressure 2 = Outlet 3 = Exhaust		
Operating head		Action	Effort (daN) with 8 bar	CODES		
Type	Operator			Operating head ALONE	Valve body + operating head	
				Instant fittings	Tapped G 1/8	
	Single lever plastic roller	Left and right	1,2	88130801 (*)	30800009	30800015
	Single lever bearing roller (CNOMO 06.05.35)	Left and right	1,2	88130802 (*)	30800010	30800016
	Adjustable lever with plastic roller	Left and right	0,4 to 1,2	88130803 (*)	30800011	30800017
	Adjustable lever with ball bearing roller	Left and right	0,4 to 1,2	88130804 (*)	30800012	30800018
	Flexible lever	Left and right	0,3 to 1,2	88130807 (*)	30800027	30800030
	Rotating head alone	Left and right	-	-	30800001	30800005

(*) The different levers are fitted to the valve fitted with a head with a side spindle (code 30800001 or 30800005)

CONNECTING

Exhaust
Flat silencers removable revealing an G 1/8 port.

Alternative pressure port G 1/8 in this case plug port (1).

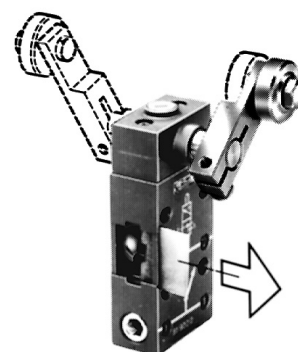
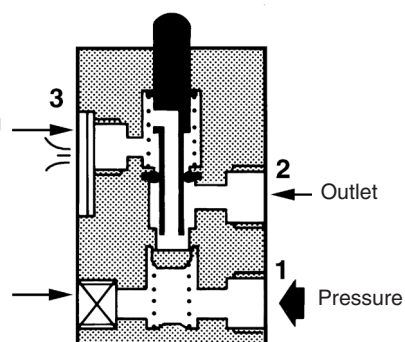

DIMENSIONS AND WEIGHTS (Max. weight : 0,200 kg)

Valve with rotating head alone

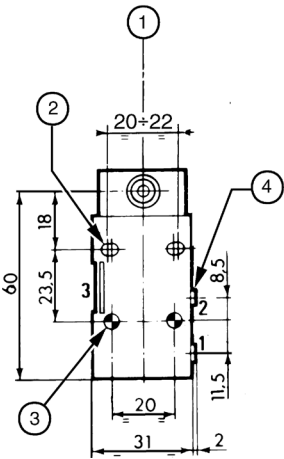

Single lever plastic roller

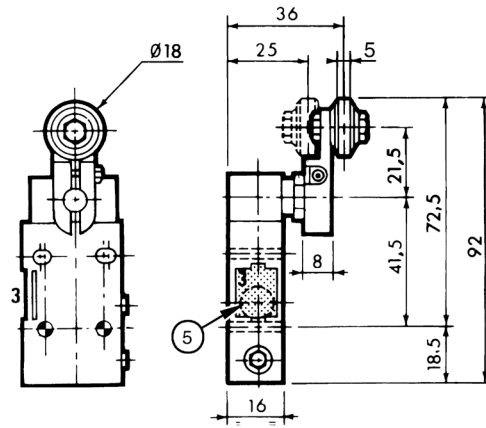

Adjustable lever with plastic roller or

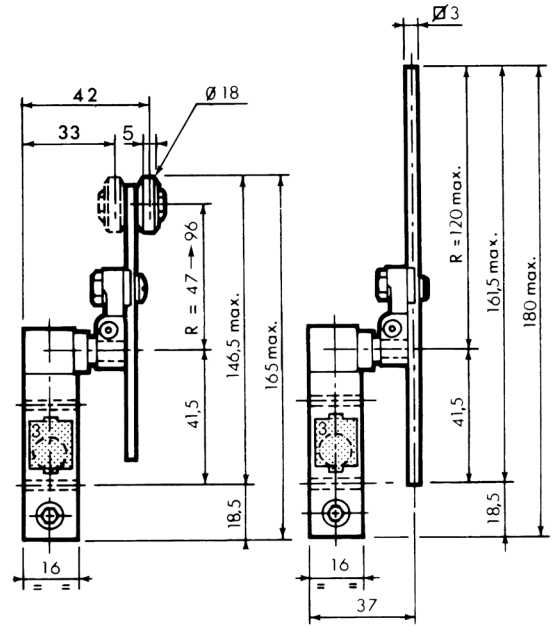

- ① Axe of the levers
- ② CENELEC mounting 2 holes Ø 4.2
- ③ CNOMO mounting 2 holes Ø 5.2
- ④ Instant fittings for tube Ø 4 mm or G 1/8
- ⑤ Exhaust with built-in silencer (can be piped G 1/8)

MOUNTING : SELECTING CONTROL POSITION

Single lever :

4 possible actions function of:

- (1) lever axe in relation to be head
- (2) roller position in relation to the lever

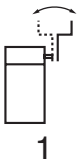

Upright adjustable lever :

2 possible mountings, by tilting the lever

Lever all types on rotating head

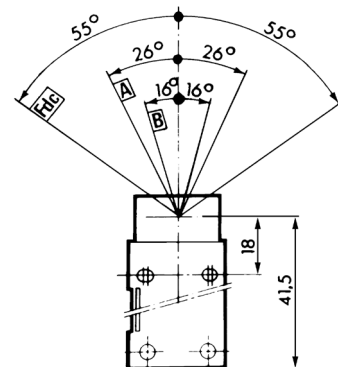

- A** Actuation point (small flow established)
- B** Release point
- Fdc** End of stroke position