

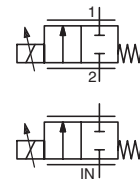

# PROPORTIONAL SOLENOID VALVE

**POSIFLOW**  
direct operated  
1/4 - 3/8

NC



**2/2**  
Series  
**202**

## FEATURES

- Variable flow, proportional to the control signal
- Valves do not require a minimum operating pressure
- Valves can be mounted in any position
- The solenoid valves satisfy all relevant EU directives

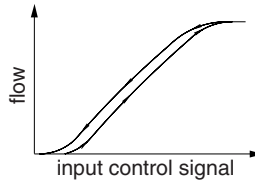

## GENERAL

**Differential pressure** See «SPECIFICATIONS» [1 bar = 100 kPa]  
**Maximum viscosity** 21 cSt (mm<sup>2</sup>/s)

fluids (*)	temperature range (TS) <sup>(2)</sup>	seal materials (*)
air, inert gas, water, oil	-10°C to +90°C	FPM (fluoroelastomer)

## MATERIALS IN CONTACT WITH FLUID

(\*) Ensure that the compatibility of the fluids in contact with the materials is verified

	Brass body	Stainless steel body
Body	Brass	AISI 303 SS
Core tube	Stainless steel	Stainless steel
Core and plugnut	Stainless steel	Stainless steel
Springs	Stainless steel	Stainless steel
Riderring	PTFE	PTFE
Seat	Brass	Stainless steel
Seal, disc	FPM	FPM
Breaker piece	Stainless steel	Stainless steel

## ELECTRICAL CHARACTERISTICS

**Coil insulation class** F  
**Connector** Spade plug (cable Ø 6-10 mm)  
**Connector specification** ISO 4400 / EN 175301-803, form A  
**Electrical safety** IEC 335  
**Electrical enclosure protection** Moulded IP65 (EN 60529)  
**Standard voltages** DC (=) : 24V (Other voltages on request)

prefix option	operating current (mA)	power ratings				operator ambient temperature range (TS) <sup>(2)</sup> (C°)	replacement coil (=)	type <sup>(1)</sup>
		inrush ~ (VA)	holding ~ (VA)	hot/cold = (W)				
SC	100 - 500	-	-	-	11 / 8	-10 to +75	24 V DC 400429-040	01

**Voltage regulation** 0 - 24 V DC  
24 V DC pulse width modulated (300 Hz)

**Flow regulation characteristics <sup>(3)</sup>** Hysteresis < 5% ; Repeatability < 3% ; Sensitivity < 2%

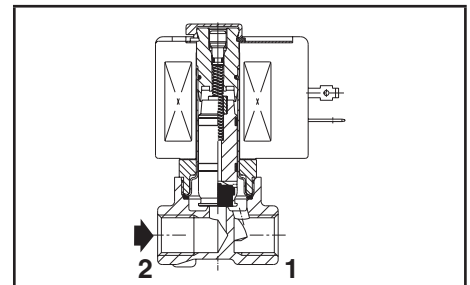

1/4 (brass body)

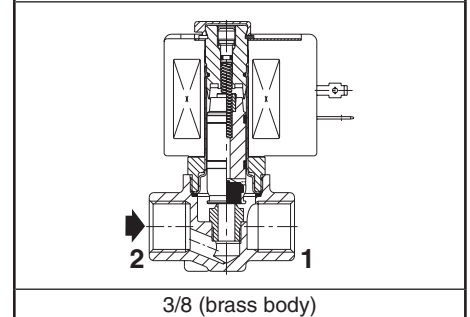

3/8 (brass body)

## SPECIFICATIONS

pipe size	orifice size (mm)	flow coefficient Kv (m <sup>3</sup> /h) (l/min)		operating pressure differential (bar)			power coil (W)	catalogue number				options			
				min.	max. (PS)			brass (=)	stainless steel (=)		EPDM	CR	PTFE		
					vacuum	air, water, oil (*)			air / inert gas	liquids				air / inert gas	liquids
<b>NC - Normally closed</b>															
1/4	G	1,2	0,05	0,8	0	1	16	8	SCG202A001V	SCG202A051V	-	-	E	J	T
	NPT	1,2	0,05	0,8	0	1	16	8	-	-	SCB202A011V	SCB202A061V	E	J	T
	G	2,4	0,12	2	0	1	8	8	SCG202A002V	SCG202A052V	-	-	E	J	T
	NPT	2,4	0,12	2	0	1	8	8	-	-	SCB202A012V	SCB202A062V	E	J	T
	G	3,2	0,24	4,0	0	1	4	8	SCG202A003V	SCG202A053V	-	-	E	J	T
	NPT	3,2	0,24	4,0	0	1	4	8	-	-	SCB202A013V	SCB202A063V	E	J	T
	G	4,0	0,42	7,0	0	1	2,5	8	SCG202A004V	SCG202A054V	-	-	E	J	T
	NPT	4,0	0,42	7,0	0	1	2,5	8	-	-	SCB202A014V	SCB202A064V	E	J	T
3/8	G	5,6	0,72	12,0	0	1	1,4	8	SCG202A006V	SCG202A056V	-	-	E	J	T
	NPT	5,6	0,72	12,0	0	1	1,4	8	-	-	SCB202A016V	SCB202A066V	E	J	T
	G	7,1	0,90	15,0	0	1	1	8	SCG202A007V	SCG202A057V	-	-	E	J	T
	NPT	7,1	0,90	15,0	0	1	1	8	-	-	SCB202A017V	SCB202A067V	E	J	T
	Rp	3,2	0,24	4,0	0	1	4	8	SCE202A023V	SCE202A073V	-	-	E	J	T
	NPT	3,2	0,24	4,0	0	1	4	8	-	-	SCB202A033V	SCB202A083V	E	J	T
	Rp	4,0	0,42	7,0	0	1	2,5	8	SCE202A024V	SCE202A074V	-	-	E	J	T
	NPT	4,0	0,42	7,0	0	1	2,5	8	-	-	SCB202A034V	SCB202A084V	E	J	T
3/8	Rp	5,6	0,72	12,0	0	1	1,4	8	SCE202A026V	SCE202A076V	-	-	E	J	T
	NPT	5,6	0,72	12,0	0	1	1,4	8	-	-	SCB202A036V	SCB202A086V	E	J	T
	Rp	7,1	0,90	15,0	0	1	1	8	SCE202A027V	SCE202A077V	-	-	E	J	T
	NPT	7,1	0,90	15,0	0	1	1	8	-	-	SCB202A037V	SCB202A087V	E	J	T

<sup>(1)</sup> Refer to the dimensional drawings on the following page.  
<sup>(2)</sup> Damage may occur when liquids solidify above the specified minimum temperature.  
<sup>(3)</sup> Percentage of max. value with 24 V DC, P.W.M. 300 Hz, supply at constant differential pressure.

### OPTIONS

- Valves can also be supplied with NBR (nitrile), EPDM (ethylene-propylene), CR (chloroprene / neoprene) and PTFE seals and discs
- Waterproof enclosure with embedded screw terminal coil according to protection class IP67, CEE-10
- Explosionproof enclosures for use in zones 1/21-2/22, categories 2-3 to ATEX Directive 2014/34/EU, on request
- Electrical enclosures according to "NEMA" standards are available
- Mounting brackets
- Electronic proportional control unit [catalogue number: **E908A001** ([www.asco.com](http://www.asco.com)) / **X90850164500100-0200** ([www.asco.com](http://www.asco.com))]  
Features:
  - analog input control signals: 0 - 10 V DC, 0 - 20 mA or 4 - 20 mA
  - coil current (= flow rate) adjustable to required control signals
  - switch-off function at less than 2% of the maximum control function
  - adjustable ramp control
  - adjustable frequency
  - output current independent of coil resistance and supply voltage variations
  - housed in: a box with spade plug connector according to ISO 4400 / IP65
- Other pipe connections are available on request

### INSTALLATION

- The solenoid valves can be mounted in any position without affecting operation
- Brass and NPT 3/8 stainless steel solenoid valves have 2 mounting holes in body
- NPT 1/4 stainless steel valves are standard supplied with mounting brackets
- Threaded pipe connection is standard: E = Rp (ISO 7/1) ; G = G (ISO 228/1) ; B = NPT (ANSI 1.20.3)
- Installation/maintenance instructions are included with each valve

### ORDERING EXAMPLES:

SC	G	202	A	001	V	24V / DC
SC	B	202	A	011	V	24V / DC
prefix	pipe thread	basic number				voltage
						suffix

### DIMENSIONS (mm), WEIGHT (kg)



**TYPE 01**  
Prefix "SC" Solenoid  
Epoxy moulded  
IEC 335 / ISO 4400  
IP65

SCG202A001V/002V/003V/004V/006V/007V  
SCB202A051V/052V/053V/054V/056V/057V

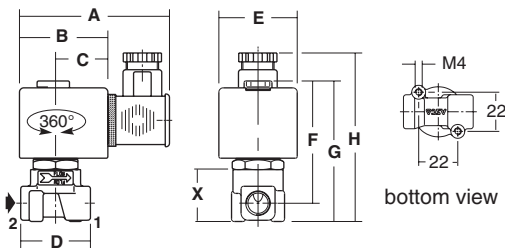

SCE202A023V/024V/026V/027V  
SCE202A073V/074V/076V/077V

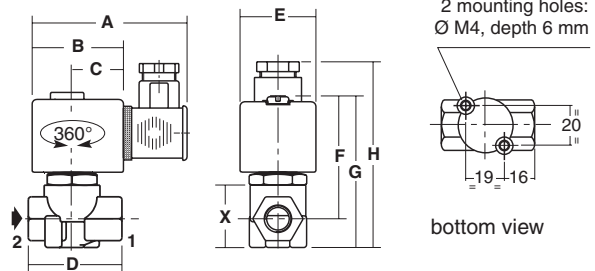

SCG202A011V/012V/013V/014V/016V/017V  
SCB202A061V/062V/063V/064V/066V/067V

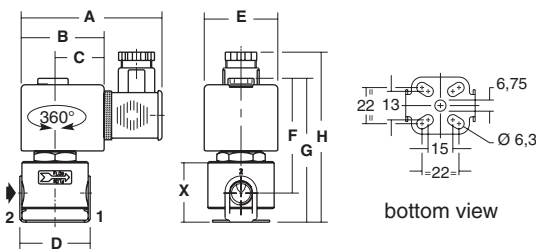

SCB202A033V/034V/036V/037V  
SCB202A083V/084V/086V/087V

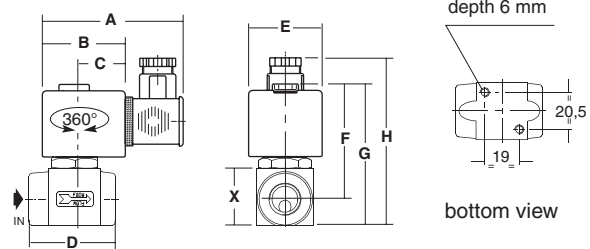

type	prefix option	catalogue number	A	B	C	D	E	F	G	H	X	weight <sup>(1)</sup>
01	SC	SCG202A001V/002V/003V/004V/006V/007V/051V/052V/053V/054V/056V/057V	85	50	30	40	45	68	79	95	30	0,50
		SCG202A011V/012V/013V/014V/016V/017V/061V/062V/063V/064V/066V/067V	80	50	30	42	45	60	79	95	37	0,60
		SCE202A023V/024V/026V/027V/073V/074V/076V/077V	80	50	30	48	45	68	82	97	32	0,50
		SCB202A033V/034V/036V/037V/083V/084V/086V/087V	80	50	30	51	45	68	81	97	31	0,65

<sup>(1)</sup> including coil and connector.