

# Flow Measurement

## SITRANS F C

### Flow sensor MASS 2100 DI 3 to DI 40

#### Overview



MASS 2100 DI 3 to DI 40 is suitable for accurate mass flow measurement of a variety of liquids and gases.

The sensor offers superior performance in terms of flow accuracy, turn-down ratio and density accuracy. The ease of installation through a "plug & play" mechanical and electrical interface ensures optimum performance and operation.

The sensor delivers true multi-parameter measurements i.e.: Mass flow, volume flow, density, temperature and fraction.

#### Benefits

- High accuracy better than 0.1 % of mass flow rate
- Large dynamic turn-down ratio better than 500:1
- Densitometer performance available through density accuracy (depending upon sensor size) ranging from 0.0005 to 0.0015 g/cm<sup>3</sup> with a typical repeatability better than 0.0001 g/cm<sup>3</sup>
- Single continuous tube design, with no internal welds, reductions or flow splitters offers optimal hygiene, safety and CIP cleanability for food and beverage and pharmaceutical applications
- Markets' thickest sensor walls ensure optimal life-time and corrosion resistance and high-pressure durability
- Full bore design provides lower pressure loss due to same internal diameter throughout the entire sensor
- Balanced pipe design with little mechanical energy loss, ensures optimal performance and stability under non-ideal and unstable process conditions (pressure, temperature, density changes etc.)
- 4-wire Pt1000 temperature measurement ensures optimum accuracy on mass flow, density and fraction flow
- Multi-plug electrical connector and SENSORPROM enables true "plug & play". Installation and commissioning in less than 10 minutes
- Intrinsically safe Ex design ia IIC as standard, making service in hazardous area possible without having to demount the sensor if a compact Ex d transmitter needs service
- Sensor pipe available in high-quality stainless steel AISI 316L/1.4435 or Hastelloy C22/2.4602 offering optimum corrosion resistance
- Centre-block design decouples process noise from the environment such as vibrations, pulsations, pressure shocks etc. making installation flexible and versatile
- Rugged and space-saving sensor design in stainless steel matching all environments
- High-pressure program as standard
- The sensor calibration factor is also valid for gas measurement
- Uniform sensor interface matching all transmitter versions at the same time whether it is compact IP67/NEMA 6, compact Ex d or remote installation, one sensor fits all

#### Application

Coriolis mass flowmeters are suitable for measuring all liquids and gases. The measurement is independent of changes in process conditions/parameters such as temperature, density, pressure, viscosity, conductivity and flow profile.

Due to this versatility the meter is easy to install and the Coriolis flowmeter is recognized for its high accuracy in a wide turn-down ratio which is a paramount in many applications.

#### The main applications of the Coriolis flowmeter can be found in all industries, such as:

<b>Chemical and pharma</b>	Detergents, bulk chemicals, pharmaceuticals, acids, alkalis
<b>Food and beverage</b>	Dairy products, beer, wine, soft-drinks, Brix/Plato, fruit juices and pulps, bottling, CO <sub>2</sub> dosing, CIP-liquids
<b>Automotive</b>	Fuel injection nozzle and pump testing, filling of AC units, engine consumption, paint robots
<b>Oil and gas</b>	Filling of gas bottles, furnace control, test separators, LPG
<b>Water and waste water</b>	Dosing of chemicals for water treatment

The wide variety of combinations and versions from the modular system means that ideal adaptation is possible to each measuring task.

#### Design

The MASS 2100 sensor consists of a single bent tube in a double bent pipe configuration, welded directly to the process connectors at each end.

The centre-block is brazed onto the sensor pipes from the outside acting as a mechanical low pass filter.

The sensor is available in 2 material configurations, AISI 316L/1.4404 or Hastelloy C22/2.4602 with a wide variety of process connections.

The enclosure is made in stainless steel AISI 316L/1.4404 with a grade of encapsulation of IP67.

The sensor is as standard Ex ia approved, intrinsically safe.

The sensor can be installed in horizontal or vertical position. In horizontal position the sensor is self draining.

**Heating Jacket:** All the sensors MASS 2100, DI 3 to DI 40, can optionally be equipped with a heating coil to avoid solidification of sensitive fluids during down-time or period between discontinuing processes. This feature gives the user an alternative to the costly electrical heating normally used, as it gives the freedom to choose either hot water, superheated steam or hot oil, to maintain a constant temperature inside the sensor.

## Flow sensor MASS 2100 DI 3 to DI 40

### Function

The measuring principle is based on the Coriolis effect. See "System information SITRANS F C Coriolis mass flowmeters".

### Integration

The sensor can be connected to all MASS 6000 transmitters for compact and remote installation as well as SIFLOW FC070 standard and Ex type transmitters.

All sensors are delivered with a SENSORPROM containing all information about calibration data, identity and factory pre-programming of transmitter settings.

### Installation guidelines MASS 2100 DI 3 ... DI 40 (1/8" ... 1 1/2")

#### Installation of sensor

In order to perform according to given specifications for flow and density accuracy, the sensor must be installed using rigid mounting brackets as shown in the installation examples.

If the liquid is volatile or contains solid particles, vertical mounting is not recommended.

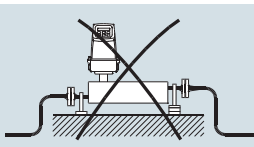
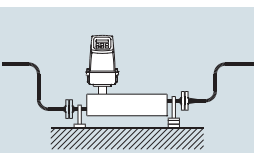
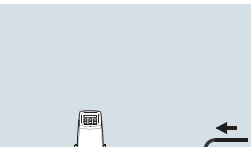
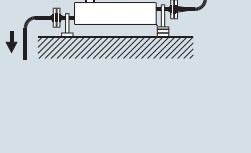
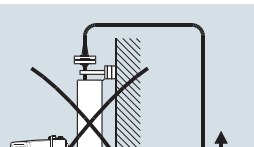
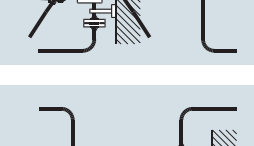
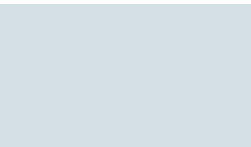
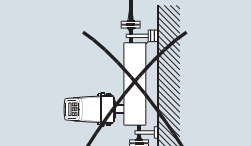
	Liquid	Gas
<b>Horizontal</b>	 	 
<b>Vertical</b>	 	 

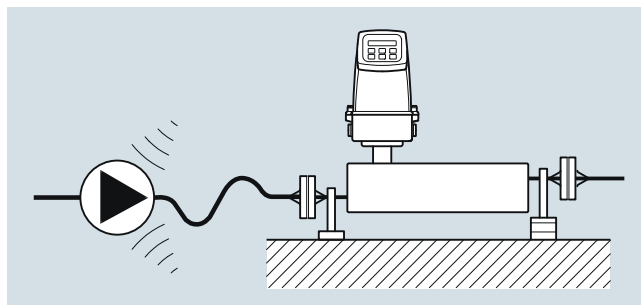
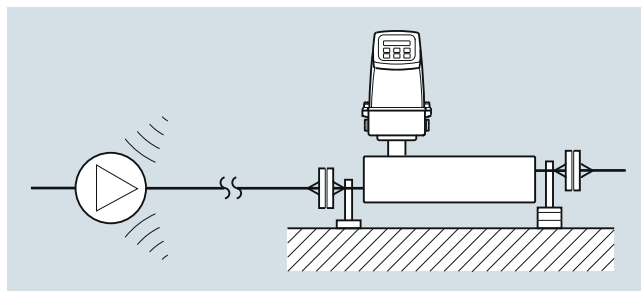

#### Vibration

Always locate the flowmeter as far away as possible from components that generate mechanical vibration in the piping.

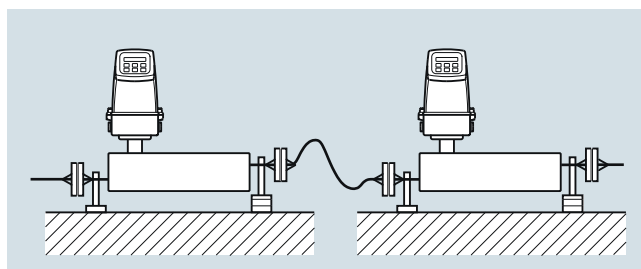

#### Cross talk

Cross talk between sensors mounted close to each other may disturb the measurement. To avoid cross talk never mount more than one meter on each frame and mount flexible hose connections between the sensors as shown.

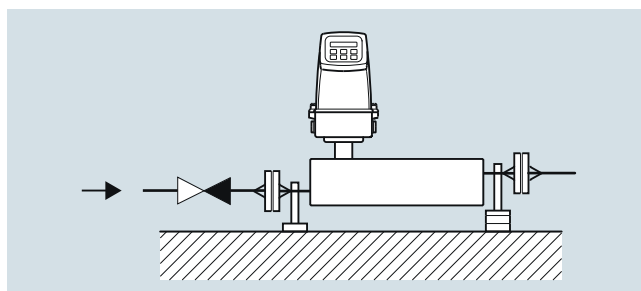

#### Zero point adjustment

To facilitate zero point adjustment a shut-off valve should always be mounted in connection with the sensor as a proper zero point setting is essential for a good accuracy.

# Flow Measurement

## SITRANS F C

### Flow sensor MASS 2100 DI 3 to DI 40

#### Technical specifications

Versions (mm (inch))	DI 3 (1/8)	DI 6 (¼)	DI 15 (5/8)	DI 25 (1)	DI 40 (1½)	
<b>Inside pipe diameter</b> (sensor consists of one continuous pipe)	mm (inch)	3.0 (0.12)	6.0 (0.24)	14.0 (0.55)	29.7 (1.17)	43.1 (1.70)
<b>Pipe wall thickness</b>	mm (inch)	0.5 (0.02)	1.0 (0.04)	1.0 (0.04)	2.0 (0.08)	2.6 (0.10)
<b>Mass flow measuring range</b>	kg/h (lb/h)	0 ... 250 (0 ... 550)	0 ... 1000 (0 ... 2200)	0 ... 5600 (0 ... 12345)	0 ... 25000 (0 ... 55100)	0 ... 52000 (0 ... 114600)
<b>Density</b>	g/cm <sup>3</sup> (lb/inch <sup>3</sup> )	0 ... 2.9 (0 ... 0.10)				
<b>Fraction e.g.</b>	°Brix	0 ... 100				
<b>Temperature</b>						
Standard	°C (°F)	-50 ... +180 °C (-58 ... +356 °F)				
<b>Liquid pressure measuring pipe<sup>1)</sup></b>						
Stainless steel	bar (psi)	230 (3336)	265 (3844)	130 (1885)	110 (1595)	105 (1523)
Hastelloy C22/2.4602	bar (psi)	350 (5076)	410 (5946)	200 (2900)	185 (2683)	not available
<b>Materials</b>						
Measuring pipe, flange and thread connection		Stainless steel AISI 316L/1.4435				
		Hastelloy C22/2.4602		not available		
<b>Enclosure and enclosure material</b>		IP67 (NEMA 4) and stainless steel AISI 316L/1.4404, <b>The housing is not rated for pressure containment</b>				
<b>Process connections<sup>2)</sup></b>						
<b>Flange</b>						
EN 1092-1, PN 40		DN 10	DN 15	DN 25	DN 40	
ANSI B16.5, Class 150		½"	½"	1"	1½"	
ANSI B16.5, Class 600 (Class 300)		½"	½"	1"	1½"	
<b>Dairy screwed connection (PN 16/25/40)<sup>3)</sup></b>						
DIN 11851		DN 10	DN 15	DN 32	DN 40	
ISO 2853/BS 4825 part 4 (SS3351)		25 mm	25 mm	38 mm	51 mm	
<b>Dairy clamp connection (PN 16)<sup>3)</sup></b>						
ISO 2852/BS 4825 part 3 (SMS3016)		25 mm	25 mm	38 mm	51 mm	
<b>Thread</b>						
ISO 228/1, PN 100		G¼" female	G¼" male	G½" male	G1" male	G2" male
ANSI/ASME B1.20.1, PN 100		¼" NPT female	¼" NPT male	½" NPT male	1" NPT male	2" NPT male
<b>Cable connection</b>		Multiple plug connection to sensor 5 x 2 x 0.35 mm <sup>2</sup> twisted and screened in pairs, ext. Ø 12 mm				
<b>Ex-version</b>		Ex ia IIC T3-T6, DEMKO 03 ATEX 135252X				
<b>Weight approx.</b>	kg (lb)	4 (8.8)	8 (17.6)	12 (26.5)	48 (105.8)	70 (154.5)

<sup>1)</sup> Max. at 20 °C (68 °F), DIN 2413, DIN 17457

<sup>2)</sup> Other connections to order, see "Selection and Ordering data"

<sup>3)</sup> Material, AISI 316/1.4401 or corresponding

For accuracy specification see "System information SITRANS F C".

# Flow Measurement SITRANS F C

## Flow sensor MASS 2100 DI 3 to DI 40

3

Pressure drop

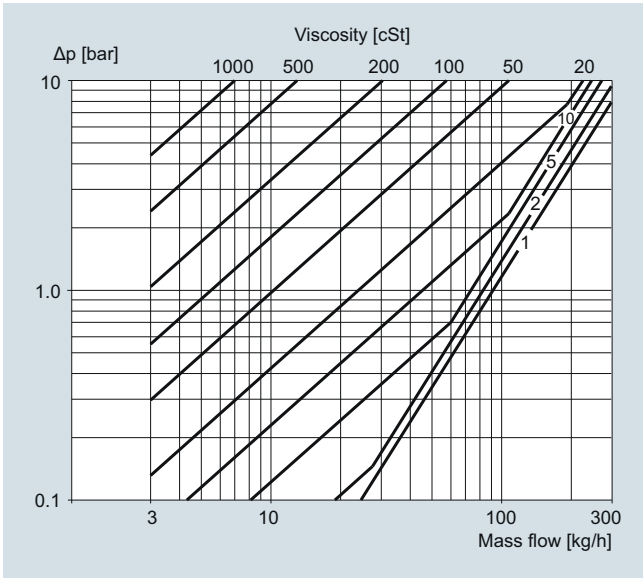

MASS 2100 DI 3 (1/8"), pressure drop for density = 1000 kg/m<sup>3</sup>

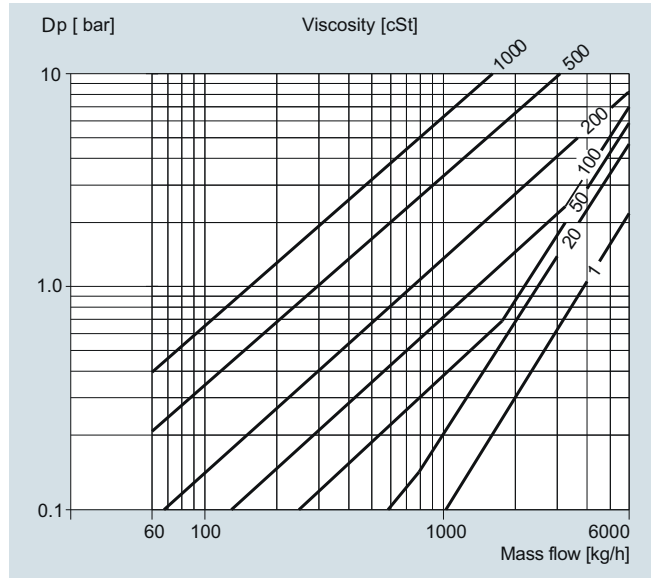

MASS 2100 DI 15 (1/2"), pressure drop for density = 1000 kg/m<sup>3</sup>

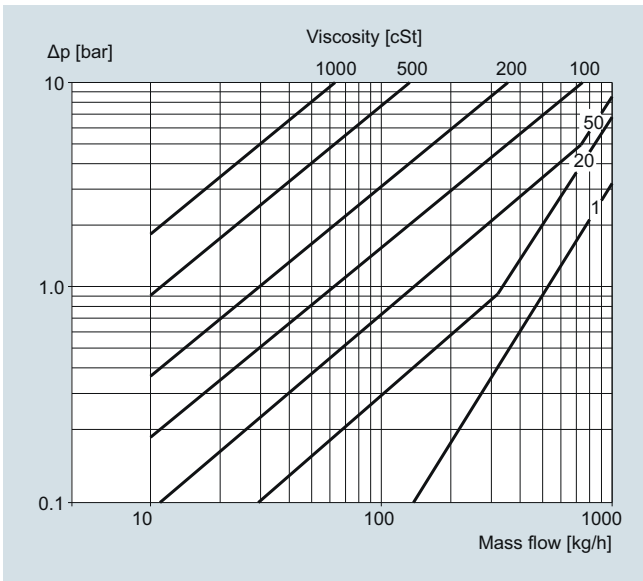

MASS 2100 DI 6 (1/4"), pressure drop for density = 1000 kg/m<sup>3</sup>

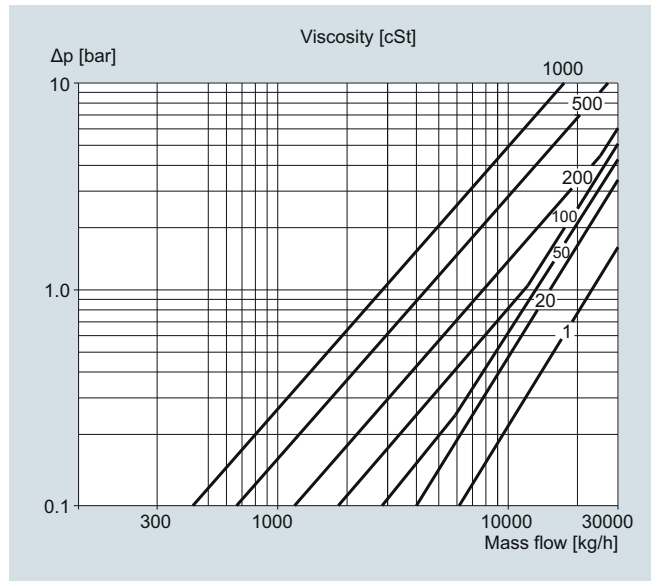

MASS 2100 DI 25 (1"), pressure drop for density = 1000 kg/m<sup>3</sup>

# Flow Measurement SITRANS F C

## Flow sensor MASS 2100 DI 3 to DI 40

3

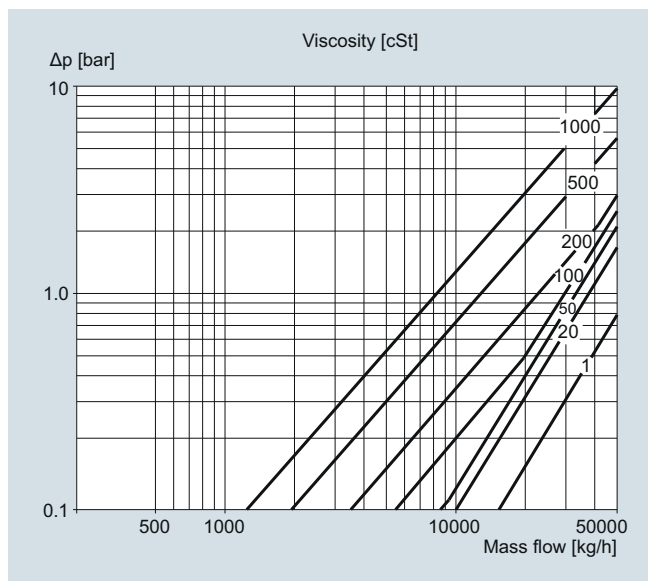

MASS 2100 DI 40 (1½"), pressure drop for density = 1000 kg/m<sup>3</sup>

### Pressure/temperature curves

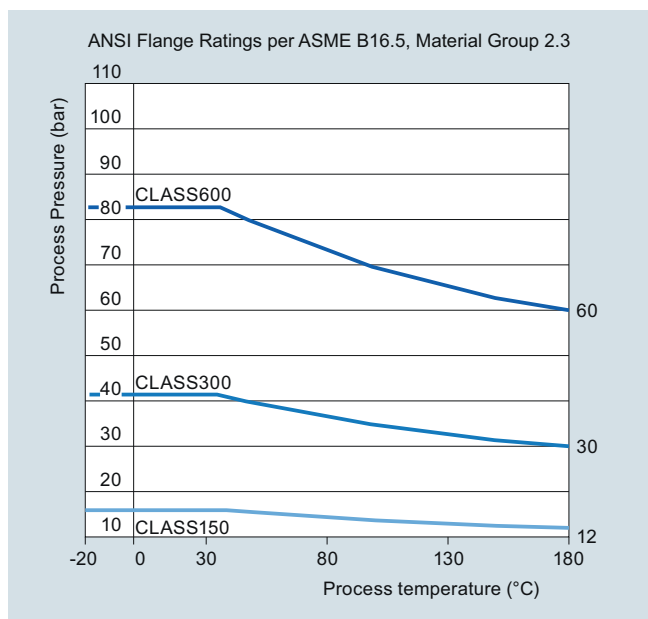

ASME flanges B16.5 stainless steel

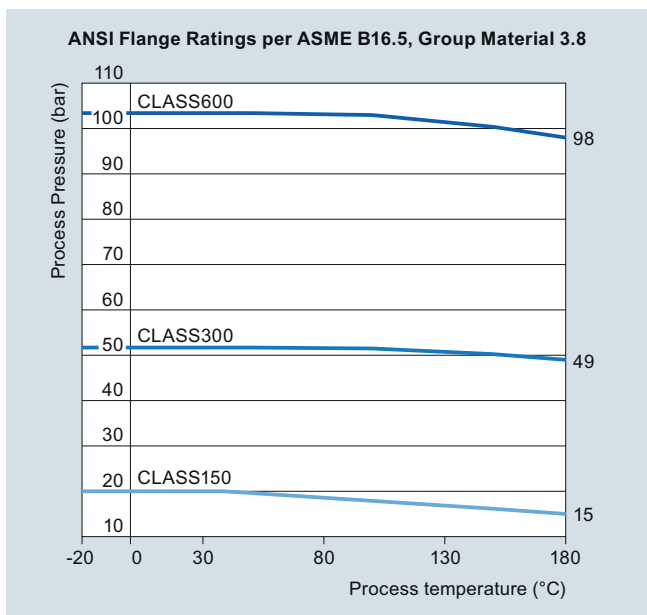

ASME flanges B16.5 Hastelloy C22/2.4602

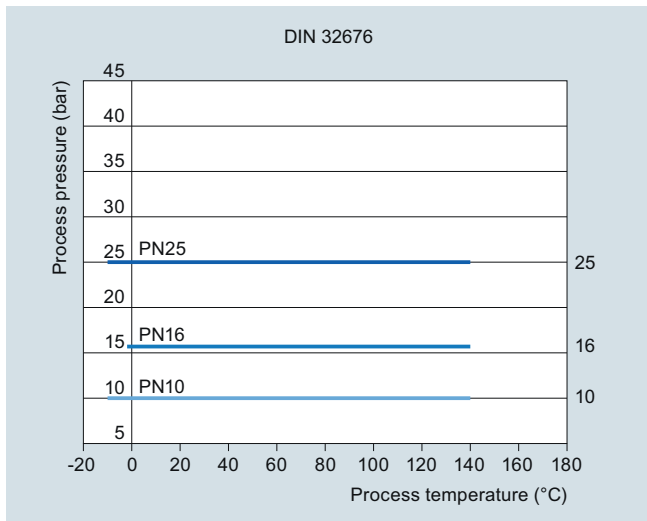

DIN 32676 flanges stainless steel (PN 10 ... PN 25)

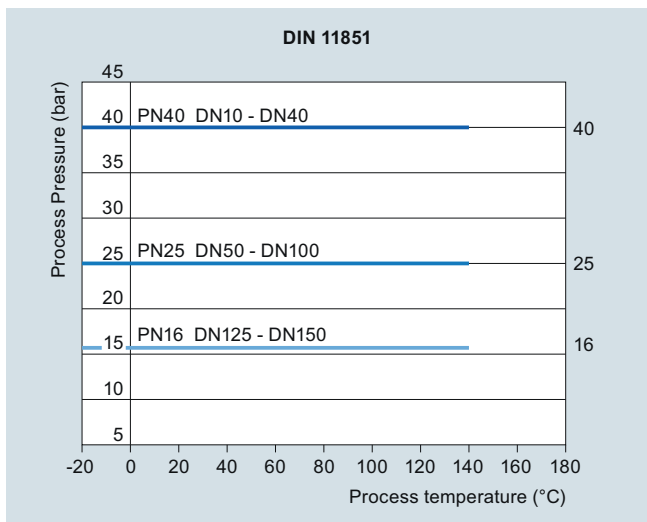

DIN 11581 flanges stainless steel (PN 25 ... PN 40)

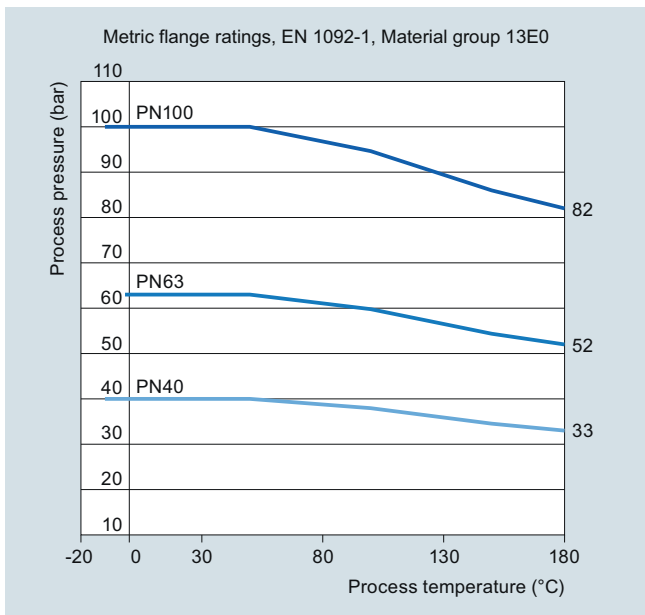

EN 1092 flanges stainless steel (PN 40 ... PN 100)

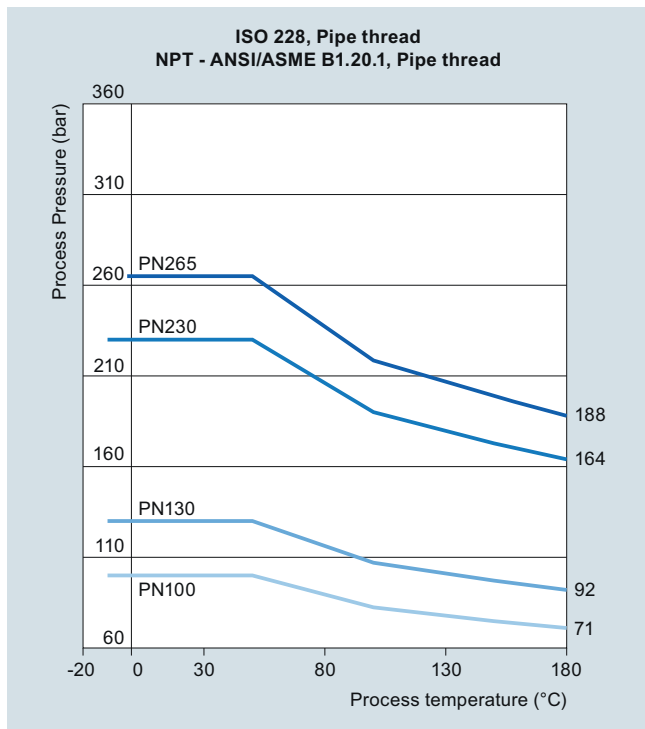

ISO 228 and NPT pipe thread stainless steel (PN 100 ... PN 265)

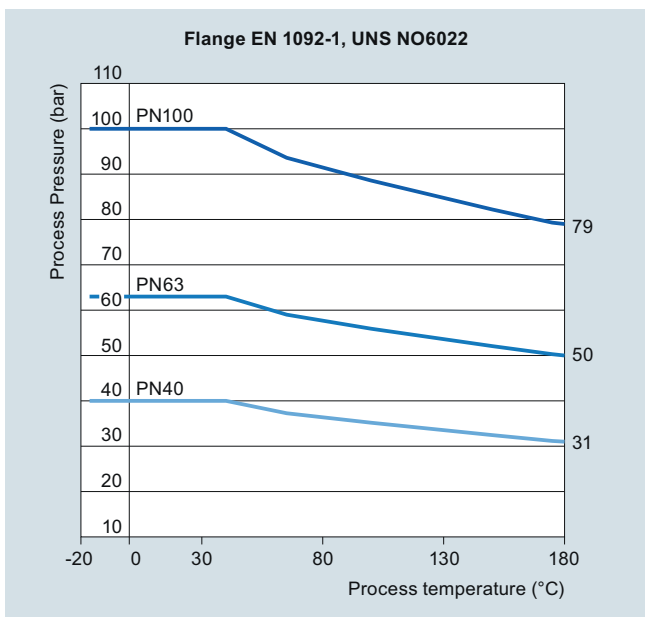

EN 1092 flanges Hastelloy C22/2.4602 (PN 40 ... PN 100)

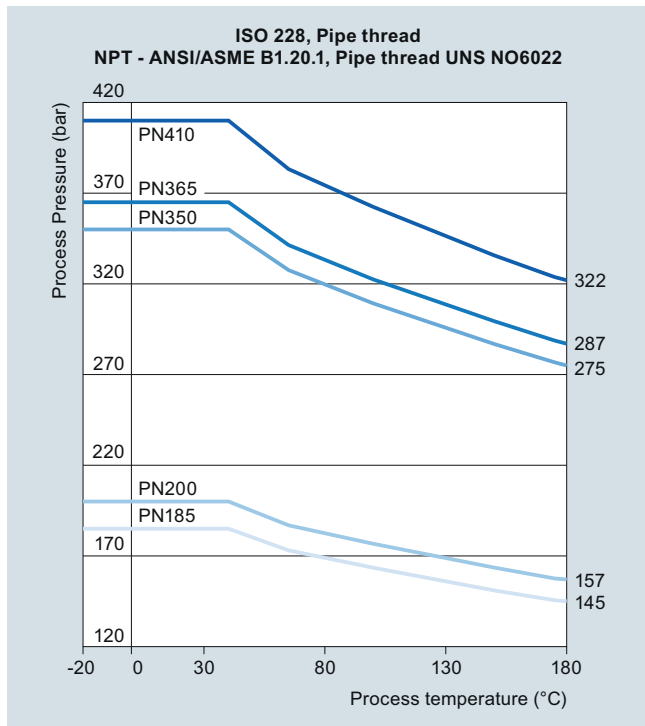

ISO 218 and NPT pipe thread stainless steel (PN 185 ... PN 410)

For further information on the PED standard and requirements, see page 9/6.

# Flow Measurement

## SITRANS F C

### Flow sensor MASS 2100 DI 3 to DI 40

Selection and Ordering data	Article No.	Ord. code
<b>SITRANS F C sensors</b>		
<b>MASS 2100 without heating jacket</b>	<b>7ME4100-</b>	
<b>MASS 2100 heated, DN 15 connection</b>	<b>7ME4200-</b>	
<b>MASS 2100 heated, ½ inch, ANSI B16.5 connection</b>	<b>7ME4210-</b>	
<b>Diameter</b>		
Stainless steel AISI 316L/1.4435 DI 3 (PN 100/PN 230)	<b>1C</b>	
DI 6	<b>1D</b>	
DI 15	<b>1E</b>	
DI 25	<b>1F</b>	
DI 40	<b>1G</b>	
Hastelloy C22/2.4602 DI 3 (PN 100/PN 350) DI 6	<b>2C</b> <b>2D</b>	
<b>Pressure</b>		
PN 16 (DI 6, DI 15, DI 25 and DI 40)	<b>A</b>	
PN 25 (DI 6, DI 15, DI 25 and DI 40)	<b>B</b>	
PN 40 (DI 6, DI 15, DI 25 and DI 40)	<b>C</b>	
PN 100 (DI 3, DI 6, DI 15, DI 25 and DI 40)	<b>D</b>	
PN 105 (DI 40, 2", AISI 316L/1.4404)	<b>E</b>	
PN 110 (DI 25, 1", AISI 316L/1.4404)	<b>F</b>	
PN 130 (DI 15, ½", AISI 316L/1.4404)	<b>G</b>	
PN 185 (DI 25, 1", Hastelloy C22/2.4602)	<b>J</b>	
PN 200 (DI 15, ½", Hastelloy C22/2.4602)	<b>K</b>	
PN 230 (DI 3, ¼", AISI 316L/1.4404)	<b>L</b>	
PN 265 (DI 6, ¼", AISI 316L/1.4404)	<b>M</b>	
PN 350 (DI 3, ¼", Hastelloy C22/2.4602)	<b>N</b>	
PN 410 (DI 6, ¼", Hastelloy C22/2.4602)	<b>Q</b>	
Class 150 (DI 6, DI 15, DI 25 and DI 40)	<b>R</b>	
Class 600 (DI 6, DI 15, DI 25 and DI 40)	<b>S</b>	
<b>Process connection/flange</b>		
Pipe thread		
G ¼"	<b>10</b>	
¼" NPT	<b>11</b>	
G ½"	<b>12</b>	
½" NPT	<b>13</b>	
G 1	<b>14</b>	
1" NPT	<b>15</b>	
G 2"	<b>16</b>	
2" NPT	<b>17</b>	
Flange EN1092-1 Form B		
DN 10 (PN 40/PN 100)	<b>20</b>	
DN 15 (PN 40/PN 100)	<b>21</b>	
DN 25 (PN 40/PN 100)	<b>22</b>	
DN 40 (PN 40/PN 100)	<b>23</b>	
DN 50 (PN 40/PN 100)	<b>24</b>	
Flange ASME/ANSI B 16.5		
½" (class 150/class 600)	<b>30</b>	
¾" (class 150/class 600)	<b>31</b>	
1" (class 150/class 600)	<b>32</b>	
1 ½" (class 150/class 600)	<b>33</b>	
2" (class 150/class 600)	<b>34</b>	

Selection and Ordering data	Article No.	Ord. code
<b>SITRANS F C sensors</b>		
<b>MASS 2100 without heating jacket</b>	<b>7ME4100-</b>	
<b>MASS 2100 heated, DN 15 connection</b>	<b>7ME4200-</b>	
<b>MASS 2100 heated, ½ inch, ANSI B16.5 connection</b>	<b>7ME4210-</b>	
<b>Dairy screwed connection DIN 11851</b>		
DN 10 (PN 40)	<b>40</b>	
DN 15 (PN 40)	<b>41</b>	
DN 25 (PN 40)	<b>42</b>	
DN 32 (PN 40)	<b>43</b>	
DN 40 (PN 25)	<b>44</b>	
DN 50 (PN 25)	<b>45</b>	
DN 65 (PN 25)	<b>46</b>	
<b>Dairy clamp connection ISO 2852 (DIN 32676)</b>		
Cone down the sensor in order to obtain self-drainage with connectors ISO 2852		
25 mm (PN 16)	<b>50</b>	
38 mm (PN 16)	<b>51</b>	
51 mm (PN 16)	<b>52</b>	
<b>Dairy screwed connection ISO 2853</b>		
25 mm (PN 16)	<b>60</b>	
38 mm (PN 16)	<b>61</b>	
51 mm (PN 16)	<b>62</b>	
<b>Configuration/calibration type</b>		
Standard		<b>1</b>
Density		<b>2</b>
Brix/Plato		<b>3</b>
Fraction (specification required)		<b>9</b>
<b>Transmitter compact mounted on sensor</b>		
No transmitter, sensor and adapter only		<b>A</b>
MASS 6000, Ex d, stainless steel enclosure, 1 current, 1 freq./pulse and 1 relay output, 24 V AC/DC with Ex de [ia/ib] T3-T6 Ex-approval		<b>B</b>
MASS 6000, IP67, Polyamide enclosure, cable glands M20, 1 current, 1 freq./pulse and 1 relay output, 24 V AC/DC		<b>C</b>
MASS 6000, IP67, Polyamide enclosure, cable glands M20, 1 current, 1 freq./pulse and 1 relay output, 115/230 V AC 50/60 Hz		<b>D</b>
MASS 6000, IP67, Polyamide enclosure, cable glands ½" NPT, 1 current, 1 freq./pulse and 1 relay output, 24 V AC/DC		<b>E</b>
MASS 6000, IP67, Polyamide enclosure, cable glands ½" NPT, 1 current, 1 freq./pulse and 1 relay output, 115/230 V AC 50/60 Hz		<b>F</b>
<b>Cable</b>		
No cable		<b>A</b>
5 m (16.4 ft) cable		<b>B</b>
10 m (32.8 ft) cable		<b>C</b>
25 m (82 ft) cable		<b>D</b>
50 m (164 ft) cable		<b>E</b>
75 m (246 ft) cable		<b>F</b>
150 m (492 ft) cable		<b>G</b>
<b>Calibration/verification</b>		
Standard calibration 3 flow x 2 points		<b>1</b>
Stand. calibration matched pair 3 flow x 2 points		<b>2</b>
Accredited calibration matched pair 5 flow x 2 points (DANAK to ISO 17025)		<b>3</b>
Extended calibration customer-specified select Y60, Y61, Y62 or Y63 (see additional information)		<b>8</b>

**Dairy MLFB example****MASS 2100**Sensor size DI 15,  
AISI 316L/1.4435

PN 40

DN 15 connector

Standard configuration/calibration

MASS 6000 IP67 compact mounted

No cable

Standard calibration, 3 flow x 2 points

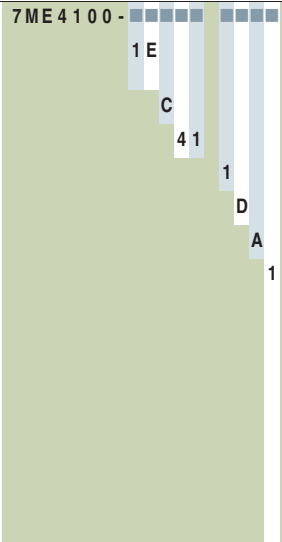
**Selection and Ordering data**

Order code

**Additional information**

Please add "-Z" to Article No. and specify Order code(s) and plain text.

Pressure testing certificate PED: 97/23/EC

**C11**

Material certificate EN 10204-3.1

**C12**

NDT- X-ray inspection report: EN 1435

**C13**

DI3 sensor only: NDT-Penetrant inspection report ISO 3452.

Factory certificate according to EN 10204 2.2

**C14**

Factory certificate according to EN 10204 2.1

**C15**

Tag name plate, stainless steel

**Y17**

Tag name plate, plastic

**Y18**

Customer-specific transmitter setup

**Y20**

Customer-specified, matched pair (5 x 2)

**Y60**

Customer-specified calibration (5 x 2)

**Y61**

Customer-specified, matched pair (10 x 1)

**Y62**

Customer-specified calibration (10 x 1)

**Y63**

Cleaned for oil and grease

**Y80**

Special version

**Y99****Operating instructions for****SITRANS F C MASS 2100 DI 3 to DI 40**

Description	Article No.
• English	<b>A5E02896535</b>
• German	<b>A5E03073519</b>
• Spanish	<b>A5E03073549</b>
• French	<b>A5E03073539</b>

This device is shipped with a Quick Start guide and a CD containing further SITRANS F literature.

All literature is also available for free at:

<http://www.siemens.com/flowdocumentation>**Selection and Ordering data****Accessories**

Description	Dimension	Article No.
Mating parts for hygienic fittings DIN 11851  Includes: • 2 unions • 2 mating parts (for welding in) • 2 EPDM gaskets	DN 10	<b>FDK:085U1016</b>
	DN 15	<b>FDK:085U1017</b>
	DN 25	<b>FDK:085U1019</b>
	DN 32	<b>FDK:085U1020</b>
	DN 40	<b>FDK:085U1021</b>
	DN 50	<b>FDK:085U1022</b>
Mating parts for hygienic clamp ISO 2852  Includes: • 2 clamps • 2 mating parts • 2 EPDM gaskets	25 mm	<b>FDK:085U1029</b>
	40 mm	<b>FDK:085U1031</b>
	50 mm	<b>FDK:085U1032</b>
2 EPDM gaskets with collar for mounting set DIN 11851	DN 10	<b>FDK:085U1006</b>
	DN 15	<b>FDK:085U1007</b>
	DN 25	<b>FDK:085U1009</b>
	DN 32	<b>FDK:085U1010</b>
	DN 40	<b>FDK:085U1011</b>
	DN 50	<b>FDK:085U1012</b>
DN 65	<b>FDK:085U1013</b>	

Description	Length	Article No.
<b>Cable with multiple plug</b> Standard blue cable between MASS 6000 and MASS 2100, 5 x 2 x 0.34 mm <sup>2</sup> twisted and screened in pairs. Temperature range -20 °C ... +110 °C (-4 °F ... +230 °F)		
	5 m (16.4 ft)	<b>FDK:083H3015</b>
	10 m (32.8 ft)	<b>FDK:083H3016</b>
	25 m (82 ft)	<b>FDK:083H3017</b>
	50 m (164 ft)	<b>FDK:083H3018</b>
	75 m (246 ft)	<b>FDK:083H3054</b>
	150 m (492 ft)	<b>FDK:083H3055</b>

**Spare parts**

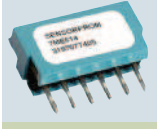
Description	Article No.
<b>Adapter for MASS 2100</b>	<b>FDK:083L8889</b>
<b>Multiple plug for cable mounting</b>	<b>FDK:083H5056</b>
<b>2 kB SENSORPROM unit, including programming</b> (Sensor Serial No. and Article No. must be specified by ordering)	 <b>FDK:083H4410</b>



# Flow Measurement

## SITRANS F C

### Flow sensor MASS 2100 DI 3 to DI 40

#### Dimensional drawings

##### MASS 2100 sensor

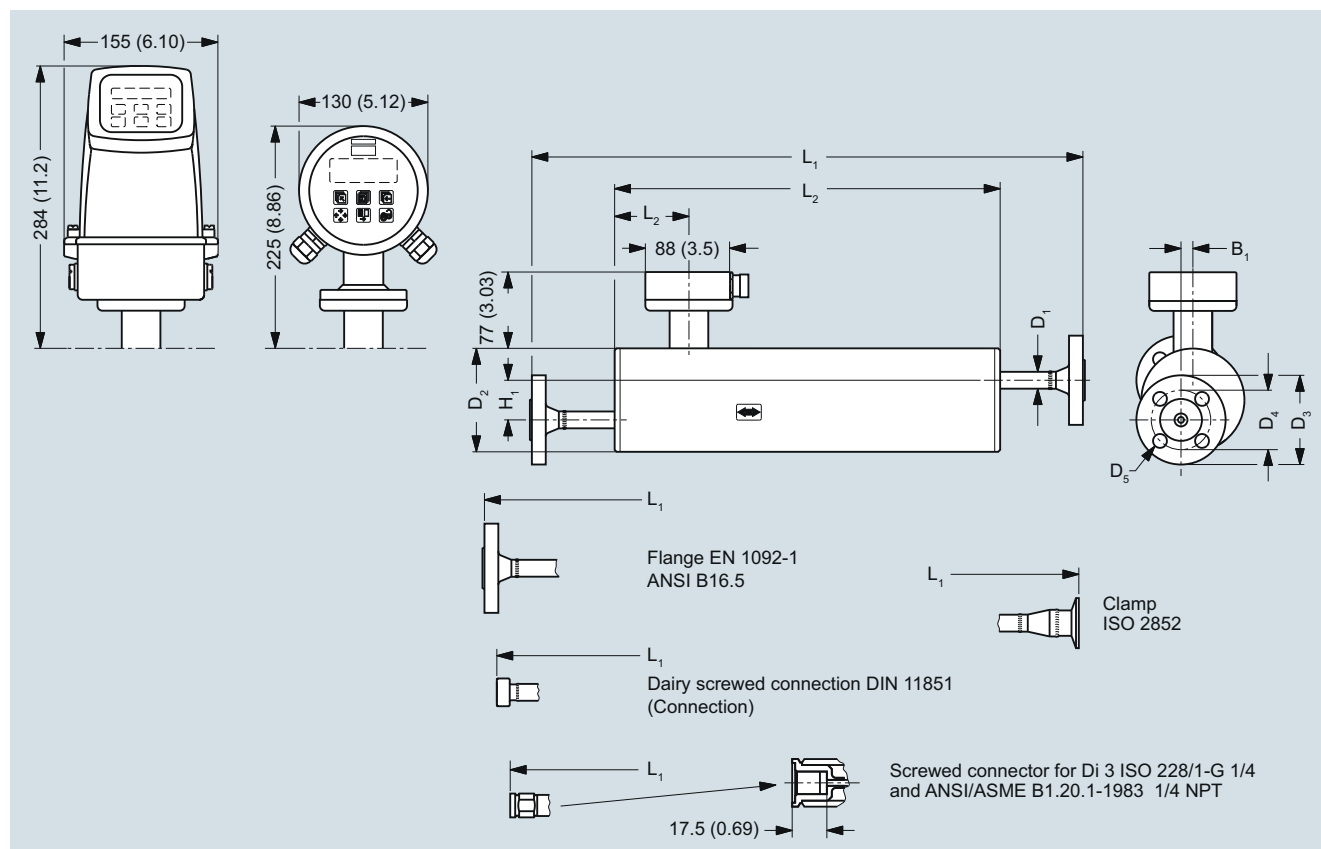

Dimension in mm (inch)

For not listed variants please contact product support

Sensor size	Connections			L1	L2	L3	H1	B1	D1	D2	D3	D4	D5
DI (inch)	Type	Pressure rating	Size	mm	mm	mm	mm	mm	mm	mm	mm	mm	mm
DI 3 (1/8)	Pipe thread ISO 228/1 - G1/4	PN 100	1/4"	400	280	75.5	60	0	21.3	104	-	-	-
	Pipe thread ANSI/ASME B 1.20.1 - 1/4" NPT	PN 100	1/4"	400	280	75.5	60	0	21.3	104	-	-	-
DI 6 (1/4)	Flange EN 1092-1	PN 100	DN 10	580	390	62.0	40	12	17.0	104	100	70.0	14.0
	Flange EN 1092-1	PN 40	DN 10	560	390	62.0	40	12	17.0	104	90.0	60.0	14.0
	Flange ANSI B16.5	Class 150	1/2"	624	390	62.0	40	12	17.0	104	88.9	60.5	15.7
	Flange ANSI B16.5	Class 600	1/2"	608	390	62.0	40	12	17.0	104	95.3	66.5	15.7
	Screwed connection DIN 11851	PN 40	DN 10	532	390	62.0	40	12	17.0	104	-	-	-
DI 15 (1/2)	Clamp ISO 2852	PN 16	25 mm	570	390	62.0	40	12	17.0	104	-	-	-
	Flange EN 1092-1	PN 100	DN 15	634	444	75.5	44	20	21.3	129	105	75.0	14.0
	Flange EN 1092-1	PN 40	DN 15	620	444	75.5	44	20	21.3	129	95.0	65.0	14.0
	Flange ANSI B16.5	Class 150	1/2"	639	444	75.5	44	20	21.3	129	88.9	60.5	15.7
	Flange ANSI B16.5	Class 600	1/2"	660	444	75.5	44	20	21.3	129	95.3	66.5	15.7
DI 25 (1)	Screwed connection DIN 11851	PN 40	DN 15	586	444	75.5	44	20	21.3	129	-	-	-
	Clamp ISO 2852	PN 16	25 mm	624	444	75.5	44	20	21.3	129	-	-	-
	Flange EN 1092-1	PN 100	DN 25	970	700	75.5	126	25	33.7	219	140.0	100.0	18.0
	Flange EN 1092-1	PN 40	DN 25	934	700	75.5	126	25	33.7	219	115.0	85.0	14.0
	Flange ANSI B16.5	Class 150	1"	967	700	75.5	126	25	33.7	219	108.0	79.2	15.7
DI 40 (1 1/2)	Flange ANSI B16.5	Class 600	1"	992	700	75.5	126	25	33.7	219	124.0	88.9	19.1
	Screwed connection DIN 11851	PN 40	DN 32	922	700	75.5	126	25	33.7	219	-	-	-
	Clamp ISO 2852	PN 16	38 mm	940	700	75.5	126	25	33.7	219	-	-	-
	Flange EN 1092-1	PN 100	DN 40	1100	850	75.5	180	0	48.3	273	170.0	125.0	22.0
	Flange EN 1092-1	PN 40	DN 40	1063	850	75.5	180	0	48.3	273	150.0	110.0	18.0
DI 40 (1 1/2)	Flange ANSI B16.5	Class 150	1 1/2"	1100	850	75.5	180	0	48.3	273	127.0	98.6	15.7
	Flange ANSI B16.5	Class 600	1 1/2"	1128	850	75.5	180	0	48.3	273	155.4	114.3	22.4
	Screwed connection DIN 11851	PN 25	DN 50	1090	850	75.5	180	0	48.3	273	-	-	-
DI 40 (1 1/2)	Clamp ISO 2852	PN 25	51 mm	1062	850	75.5	180	0	48.3	273	-	-	-

For not listed variants please contact product support.

Sensor size	Connections			L1	L2	L3	H1	B1	D1	D2	D3	D4	D5
DI (inch)	Type	Pressure rating	Size	inch	inch	inch	inch	inch	inch	inch	inch	inch	inch
DI 3 (1/8)	Pipe thread ISO 228/1 - G 1/4	PN 100	1/4"	15.75	11.02	2.97	2.36	0	0.84	4.09	-	-	-
	Pipe thread ANSI/ASME B 1.20.1 - 1/4" NPT	PN 100	1/4"	15.75	11.02	2.97	2.36	0	0.84	4.09	-	-	-
DI 6 (1/4)	Flange EN 1092-1	PN 100	DN 10	22.83	15.35	2.44	1.57	0.47	0.67	4.09	3.94	2.76	0.55
	Flange EN 1092-1	PN 40	DN 10	22.05	15.35	2.44	1.57	0.47	0.67	4.09	3.54	2.36	0.55
	Flange ANSI B16.5	Class 150	1/2"	24.57	15.35	2.44	1.57	0.47	0.67	4.09	3.5	2.38	0.62
	Flange ANSI B16.5	Class 600	1/2"	23.94	15.35	2.44	1.57	0.47	0.67	4.09	3.75	2.62	0.62
	Screwed connection DIN 11851	PN 40	DN 10	20.94	15.35	2.44	1.57	0.47	0.67	4.09	-	-	-
	Clamp ISO 2852	PN 16	25 mm	22.44	15.35	2.44	1.57	0.47	0.67	4.09	-	-	-
DI 15 (1/2)	Flange EN 1092-1	PN 100	DN 15	24.96	17.48	2.97	1.73	0.79	0.84	5.08	2.95	4.13	0.55
	Flange EN 1092-1	PN 40	DN 15	24.41	17.48	2.97	1.73	0.79	0.84	5.08	3.74	2.56	0.55
	Flange ANSI B16.5	Class 150	1/2"	25.16	17.48	2.97	1.73	0.79	0.84	5.08	3.5	2.38	0.62
	Flange ANSI B16.5	Class 600	1/2"	25.98	17.48	2.97	1.73	0.79	0.84	5.08	3.75	2.62	0.62
	Screwed connection DIN 11851	PN 40	DN 15	23.07	17.48	2.97	1.73	0.79	0.84	5.08	-	-	-
	Clamp ISO 2852	PN 16	25 mm	24.57	17.48	2.97	1.73	0.79	0.84	5.08	-	-	-
DI 25 (1)	Flange EN 1092-1	PN 100	DN 25	38.19	27.56	2.97	4.96	0.98	1.33	8.62	3.94	5.51	0.71
	Flange EN 1092-1	PN 40	DN 25	36.77	27.56	2.97	4.96	0.98	1.33	8.62	4.53	3.35	0.55
	Flange ANSI B16.5	Class 150	1"	38.07	27.56	2.97	4.96	0.98	1.33	8.62	4.25	3.12	0.62
	Flange ANSI B16.5	Class 600	1"	39.06	27.56	2.97	4.96	0.98	1.33	8.62	4.88	3.50	0.75
	Screwed connection DIN 11851	PN 40	DN 32	36.30	27.56	2.97	4.96	0.98	1.33	8.62	-	-	-
	Clamp ISO 2852	PN 16	38 mm	37.01	27.56	2.97	4.96	0.98	1.33	8.62	-	-	-
DI 40 (1 1/2)	Flange EN 1092-1	PN 100	DN 40	43.31	33.46	2.97	7.09	0	1.9	10.75	4.92	6.69	0.87
	Flange EN 1092-1	PN 40	DN 40	41.85	33.46	2.97	7.09	0	1.9	10.75	5.91	4.33	0.71
	Flange ANSI B16.5	Class 150	1 1/2"	43.31	33.46	2.97	7.09	0	1.9	10.75	5	3.88	0.62
	Flange ANSI B16.5	Class 600	1 1/2"	44.41	33.46	2.97	7.09	0	1.9	10.75	6.12	4.50	0.88
	Screwed connection DIN 11851	PN 25	DN 50	42.91	33.46	2.97	7.09	0	1.9	10.75	-	-	-
	Clamp ISO 2852	PN 25	51 mm	41.81	33.46	2.97	7.09	0	1.9	10.75	-	-	-

# Flow Measurement

## SITRANS F C

### Flow sensor MASS 2100 DI 3 to DI 40

MASS 2100 sensor with "heating jacket"

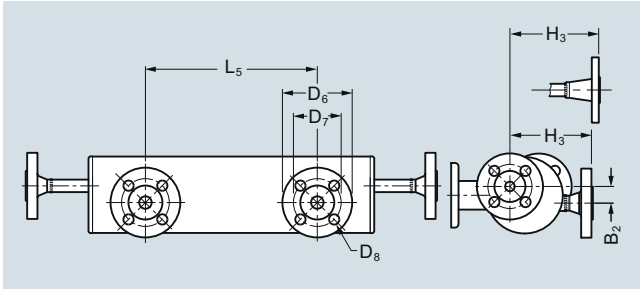

Dimensions in mm (inch)

Sensor size	Connections heated			L5	H3	B2	D6	D7	D8
DI (inch)	Type	Pressure rating	Size	mm (inch)	mm (inch)	mm (inch)	mm (inch)	mm (inch)	mm (inch)
DI 3 (1/8)	EN 1092-1	PN 40	DN 15	234 (9.21)	122 (4.8)	22 (0.87)	95 (3.74)	65.0 (2.56)	14.0 (0.55)
	ANSI B16.5	Class 150	1/2"	234 (9.21)	131.6 (5.18)	22 (0.87)	88.9 (3.5)	60.5 (2.38)	15.7 (0.62)
DI 6 (1/4)	EN 1092-1	PN 40	DN 15	234 (9.21)	112 (4.41)	22.7 (0.89)	95 (3.74)	65.0 (2.56)	14.0 (0.55)
	ANSI B16.5	Class 150	1/2"	234 (9.21)	121.6 (4.79)	22.7 (0.89)	88.9 (3.5)	60.5 (2.38)	15.7 (0.62)
DI 15 (1/2)	EN 1092-1	PN 40	DN 15	234 (9.21)	126.5 (4.98)	31.5 (1.24)	95 (3.74)	65.0 (2.56)	14.0 (0.55)
	ANSI B16.5	Class 150	1/2"	234 (9.21)	136.1 (5.36)	31.5 (1.24)	88.9 (3.5)	60.5 (2.38)	15.7 (0.62)
DI 25 (1)	EN 1092-1	PN 40	DN 15	420 (16.54)	213.6 (8.41)	60 (2.36)	95 (3.74)	65.0 (2.56)	14.0 (0.55)
	ANSI B16.5	Class 150	1/2"	420 (16.54)	223.2 (8.79)	60 (2.36)	88.9 (3.5)	60.5 (2.38)	15.7 (0.62)
DI 40 (1 1/2)	EN 1092-1	PN 40	DN 15	500 (19.68)	267.5 (10.53)	43 (1.69)	95 (3.74)	65.0 (2.56)	14.0 (0.55)
	ANSI B16.5	Class 150	1/2"	500 (19.68)	277.1 (10.91)	43 (1.69)	88.9 (3.5)	60.5 (2.38)	15.7 (0.62)

MASS 2100 and MASS 6000 Ex d compact version

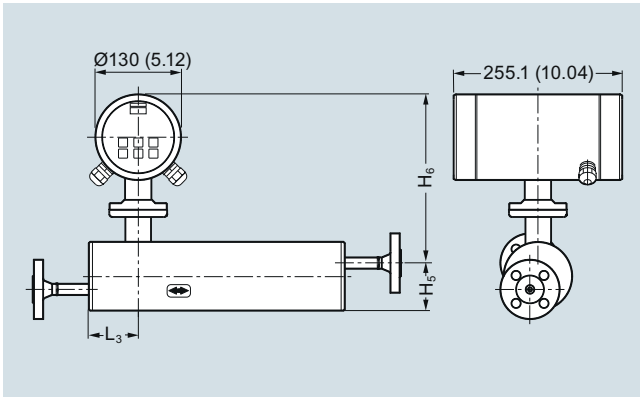

Dimensions in mm (inch)

Sensor size	L <sub>3</sub>	H <sub>5</sub>	H <sub>6</sub>	H <sub>5</sub> + H <sub>6</sub>
[DI (inch)]	[mm (inch)]	[mm (inch)]	[mm (inch)]	[mm (inch)]
3 (1/8)	75 (2.95)	82 (3.23)	247 (9.72)	329 (12.95)
6 (1/4)	62 (2.44)	72 (2.83)	257 (10.12)	329 (12.95)
15 (1/2)	75 (2.95)	87 (3.43)	267 (10.51)	354 (13.94)
25 (1)	75 (2.95)	173 (6.81)	271 (10.67)	444 (17.48)
40 (1 1/2)	75 (2.95)	227 (8.94)	271 (10.67)	498 (19.61)

MASS 2100 and MASS 6000 IP67 compact version

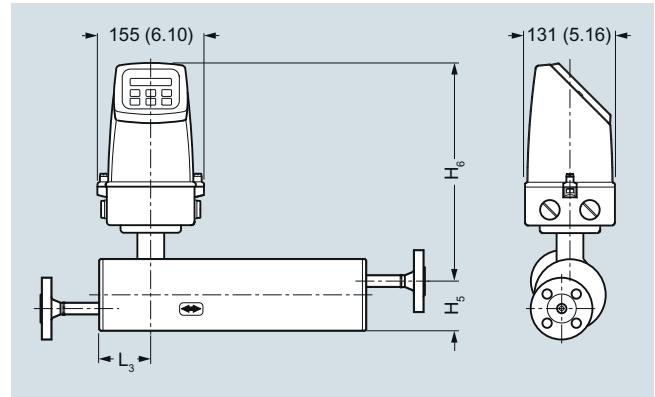

Dimensions in mm (inch)

Sensor size	L <sub>3</sub>	H <sub>5</sub>	H <sub>6</sub>	H <sub>5</sub> + H <sub>6</sub>
[DI (inch)]	[mm (inch)]	[mm (inch)]	[mm (inch)]	[mm (inch)]
3 (1/8)	75 (2.95)	82 (3.23)	306 (12.04)	388 (15.28)
6 (1/4)	62 (2.44)	72 (2.83)	316 (12.44)	388 (15.28)
15 (1/2)	75 (2.95)	87 (3.43)	326 (12.83)	413 (16.26)
25 (1)	75 (2.95)	173 (6.81)	330 (13.00)	503 (19.80)
40 (1 1/2)	75 (2.95)	227 (8.94)	330 (13.00)	557 (21.93)